



Victorian Stone





Iris Ceramica	3
Victorian Stone	4
Image Gallery	10
Large formats	40
White body coverings	46
Outdoor	60
Specifiche tecniche	65
Tech and specs	
Grès porcellanato	66
Porcelain stoneware	
Pezzi speciali	71
Trims	
Rivestimenti	72
Wall surfaces	
Safe System	74
Imballi	75
Packing	
Caratteristiche tecniche	76
Technical characteristics	



Collezione Tipi. 1976.



Iris Ceramica

Poesia della materia nel segno dell'innovazione

Poetry of matter in the name of innovation • Poésie de la matière au nom de l'innovation • Poesie der Materie im Namen der Innovation • Poesía de la materia en nombre de la innovación • Поэзия материи во имя инноваций • 以創新之名寫物詩

IT Iris Ceramica, protagonista internazionale nel settore dei rivestimenti, realizza superfici in gres porcellanato e ceramica di alta gamma per progetti in ambito residenziale, contract e industriale. Vocazione alla sperimentazione e all'innovazione, capacità di anticipare le evoluzioni dell'abitare e attenzione al benessere delle persone e dell'ambiente sono i punti di forza che hanno permesso a Iris Ceramica di rappresentare il miglior design Made in Italy nel mondo. Brand di Iris Ceramica Group, da oltre 60 anni crea superfici di design, funzionali, dalle elevate prestazioni e dalla bellezza duratura. Coniugando tecnologie di ultima generazione con saper fare artigianale, Iris Ceramica guarda al futuro con il fermo obiettivo di offrire soluzioni all'avanguardia, in grado di soddisfare le più diverse esigenze progettuali.

EN International leader in the wall coverings industry, Iris Ceramica has been producing high-end porcelain stoneware and ceramic tiles for projects in residential, contract, and industry settings. Having experimentation and innovation in its DNA, an ability to foresee trends in home design, and dedication to the wellbeing of people and the environment are the strengths that have made Iris Ceramica a world ambassador for Italian design and manufacturing. Included among the Iris Ceramica Group brands, it has been creating high-performance designed tiling for over 60 years, all with lasting beauty. Combining up-to-the minute technology and craftsmanship, Iris Ceramica's vision for the future involves goals such as offering cutting-edge solutions to meet the most divergent design needs.

FR Iris Ceramica, protagoniste internationale dans le secteur des revêtements, réalise des surfaces en grès cérame et céramique haut de gamme pour des projets résidentiels, contractuels et industriels. La vocation à l'expérimentation et à l'innovation, la capacité d'anticiper les évolutions de la vie et l'attention au bien-être des personnes et de l'environnement sont les points forts qui ont permis à Iris Ceramica de représenter le meilleur design Made in Italy dans le monde. Marque du groupe Iris Ceramica, elle crée depuis plus de 60 ans des surfaces design, fonctionnelles, performantes et d'une beauté durable. Alliant des technologies de dernière génération et savoir-faire artisanal, Iris Ceramica se tourne vers l'avenir avec l'objectif ferme d'offrir des solutions à l'avant-garde, en mesure de satisfaire les exigences conceptuelles les plus disparates.

CH Iris Ceramica 是国际墙砖行业内的重要企业，一直面向住宅、定制家具和工业领域的项目生产高端珐琅和陶瓷面砖。对实验和创新的热爱、成功预测生活演变的能力以及对人类福祉和环境的关注，是让 Iris Ceramica 能够代表全球最佳“Made in Italy”设计的优势。60 多年来，Iris Ceramica 集团的品牌一直在创造汇集设计感和实用性的面砖，产品高端且具持久美感。通过将最新一代技术与手工技艺相结合，Iris Ceramica 以提供前卫的解决方案作为坚定目标展望未来，能够满足最多样化设计需求。

DE Iris Ceramica, ein internationaler Protagonist im Bereich der Wandbeläge, produziert hochwertige Oberflächen aus Feinsteinzeug und Keramik für Projekte im Wohn-, Objekt- und Industriebereich. Eine Berufung zum Experimentieren und zur Innovation, die Fähigkeit, den Entwicklungen des Wohnens vorzugreifen, und die Aufmerksamkeit gegenüber dem Wohlergehen von Mensch und Umwelt sind die Stärken, die es Iris Ceramica ermöglicht haben, das weltbeste Design Made in Italy zu repräsentieren. Die Marke der Iris Ceramica Group stellt seit über 60 Jahren Designoberflächen her, die zweckmäßig, leistungsstark und von dauerhafter Schönheit sind. Durch die Kombination modernster Technologien mit der Handwerkskunst blickt Iris Ceramica mit dem festen Ziel in die Zukunft, innovative Lösungen anzubieten, die in der Lage sind, die unterschiedlichsten Entwurfsanforderungen zu erfüllen.

ES Iris Ceramica, protagonista internacional en el sector de los revestimientos, realiza superficies en gres porcelánico y cerámica de alta gama para proyectos en ámbito residencial, empresarial e industrial. Vocación para la experimentación y la innovación, capacidad de anticipar las evoluciones del habitar y atención al bienestar de las personas y del ambiente, son los factores cualificantes que han permitido a Iris Ceramica representar el mejor diseño Made in Italy en el mundo. Marca de Iris Ceramica Group, desde hace más de 60 años crea superficies de diseño funcionales, de elevadas prestaciones y duradera belleza. Conjugando tecnologías de última generación con la sabiduría artesanal, Iris Ceramica mira al futuro con el firme objetivo de ofrecer soluciones de vanguardia capaces de satisfacer los más variados requerimientos proyectuales.

RU «Iris Ceramica» - международный лидер в области напольных покрытий, выпускает высококачественные керамогранитные и керамические покрытия для жилых, промышленных и контрактных проектов. Склонность к экспериментам и инновациям, способность предвидеть эволюцию образа жизни, внимание к благополучию людей и окружающей среды являются сильными сторонами, которые позволили «Iris Ceramica» представить лучший дизайн «Made in Italy» во всем мире. Бренд «Iris Ceramica Group» уже более 60 лет создает дизайнерские, функциональные, высокопроизводительные и долговечные покрытия. Сочетание технологий последнего поколения с авторским ноу-хау, Iris Ceramica смотрит в будущее с твердой целью предлагать только передовые решения, удовлетворяющие самым разнообразным запросам в области дизайна.



Victorian Stone

Nobiltà naturale

Natural nobility • Noblesse naturelle • Natürliche Noblesse • Nobleza natural
• Благородная естественность • 天生贵气

IT Una pietra di origine inglese dal carattere nobile rivive in un progetto che combina ricerca estetica e tecnologia per esaltare le sue qualità con un originale accento contemporaneo. La spontaneità della materia naturale si fa così moderna applicazione di design, permettendo di rivestire molteplici tipologie di spazi - anche grazie alla disponibilità di cinque finiture superficiali pensate per altrettante destinazioni (Natural, Natural Plus R10, Antislip pensata per gli esterni, Rigata e Flamed) - con un fascino fuori dal tempo e insieme profondamente attuale. Proponendo un'avanzata osmosi tra stile, prestazioni e completezza.

EN An English stone of noble heritage is reborn in a project that seamlessly blends aesthetic exploration with cutting-edge technology, enhancing its qualities with a distinctive contemporary touch. The natural beauty of the stone is transformed into a modern design application, making it ideal for a wide variety of spaces. This versatility is further enriched by five meticulously crafted surface finishes (Natural, Natural Plus R10, Antislip for exteriors, Structured, and Flamed), each tailored to specific settings. The result is a design that exudes both timeless elegance and modern appeal, embodying a perfect fusion of style, functionality, and comprehensive design.

FR Une pierre d'origine anglaise au caractère noble renaît dans un projet alliant recherche esthétique et technologie pour exalter ses qualités avec une touche contemporaine originale. La spontanéité de la matière naturelle se transforme ainsi en une application design moderne qui permet de revêtir de nombreuses typologies d'espaces - grâce également à la disponibilité de cinq finitions superficielles conçues pour autant de destinations (Natural, Natural Plus R10, Antislip spécialement conçue pour les extérieurs, Structured et Flamed) - avec un charme à la fois intemporel et profondément actuel. Le tout en proposant une osmose avancée entre style, performances et perfection.

DE Eine Gesteinsart englischen Ursprungs mit edlem Charakter erwacht in einem Projekt zu neuem Leben, das dank der Fusion von ästhetischer Forschung und Technologie ihre Qualitäten mit einem originellen zeitgenössischen Akzent aufwertet. Die Spontaneität des Naturmaterials wird so zu einer modernen Designanwendung, die es ermöglicht, verschiedene Arten von Räumen zu verkleiden - auch dank der Verfügbarkeit von fünf Oberflächen-Finishs, die für ebenso viele Verwendungszwecke konzipiert wurden (Natural, Natural Plus R10, Antislip für den Außenbereich, Structured und Flamed). Sie bieten eine perfekte Symbiose aus Stil, Leistung und Perfektion.

ES Una piedra de origen inglés y carácter noble revive en un proyecto que combina la búsqueda estética y la tecnología para potenciar sus cualidades con un original acento contemporáneo. La espontaneidad de la materia natural se convierte así en moderna aplicación del diseño, que permite revestir múltiples tipos de espacios, también gracias a la disponibilidad de cinco acabados superficiales concebidos para otros tantos destinos - Natural, Natural Plus R10, Antideslizante (Antislip) pensado para exteriores, Estructurado (Structured) y Flameado (Flamed) - con un atractivo intemporal y, al mismo tiempo, profundamente actual. Proponiendo una ósmosis avanzada entre estilo, prestaciones y compleción.

RU Английский камень благородного происхождения обретает новую жизнь в проекте, который сочетает эстетические исследования и технологии, чтобы подчеркнуть его достоинства с оригинальным современным акцентом. Естественная спонтанность природного материала становится современным дизайнерским решением, позволяя оформлять самые разные типы пространств — в том числе благодаря наличию пяти видов поверхностной отделки, предназначенных для различных сфер применения (Natural, Natural Plus R10, Antislip для уличного применения, Structured и Flamed), с вневременным и одновременно актуальным шармом. Это воплощение передовой осмоса между стилем, функциональностью и полнотой предложения.

CH 来自英国的高贵石材，在一款结合了美学与科技追求的产品中获得新生，彰显散发独特当代气息的品质。如此，天然材质的真我个性成就了现代的设计应用，可以装饰多种多样的空间类型，这也得益于专为多种用途设计的五种饰面（Natural, Natural Plus R10, 为户外设计的Antislip, Structured和Flamed），具有时尚而隽永的魅力。风格、性能与完整性融为一体。



Victorian Stone Baycliff Black natural plus

Spaziando da tonalità chiare e luminose ad altre più scure e intense, i cinque colori in gamma restituiscono altrettanti modi di manifestarsi della pietra naturale. E offrono così l'opportunità di trovare sempre la giusta chiave emozionale per personalizzare gli ambienti, anche dando vita ad accattivanti fusioni in & out.

EN Available in five colors, ranging from light and bright to deep and intense, the palette mirrors the diverse expressions of natural stone, offering the perfect emotional resonance for any space, also creating a captivating sense of indoor-outdoor continuity.

FR En passant des nuances claires et lumineuses à d'autres plus foncées et intenses, les cinq couleurs de la gamme offrent cinq façons différentes d'exprimer la pierre naturelle. Sans compter l'opportunité de toujours trouver l'émotion parfaite pour personnaliser les espaces, y compris en créant des fusions entre intérieur/extérieur captivantes.

DE Von hellen, leuchtenden Tönen bis hin zu dunklen, intensiven Nuancen bieten die fünf Farben der Palette ebenso viele Möglichkeiten, den Naturstein zur Geltung zu bringen. So lässt sich immer der richtige emotionale Schlüssel für die individuelle Gestaltung von Räumen finden und sogar eine faszinierende Verschmelzung von Innen und Außen schaffen.

ES Desde los tonos claros y luminosos hasta los más oscuros e intensos, los cinco colores de la gama brindan otras tantas formas de manifestarse de la piedra natural. Y ofrecen así la oportunidad de encontrar siempre la clave emocional adecuada para personalizar los ambientes, creando incluso cautivadoras fusiones de interior y exterior.

RU Цветовая гамма состоит из пяти цветов от светлых и бледных до насыщенных темных, каждый из которых по-своему интерпретирует природный камень. Это позволяет подобрать нужный вариант для желаемого эмоционального восприятия любого пространства, а также оформить интерьер в доме и на улице в едином привлекательном стиле.

CH 从明亮的浅色到更深邃强烈的颜色，系列提供的五种色彩为天然石材赋予了多种表达形式。这有助于找到恰到好处的情感钥匙，为环境增添个性，打造室内外融为一体的动人氛围。



floor: Victorian Stone Limestone Beige natural plus 100x100 cm . 40"x40"

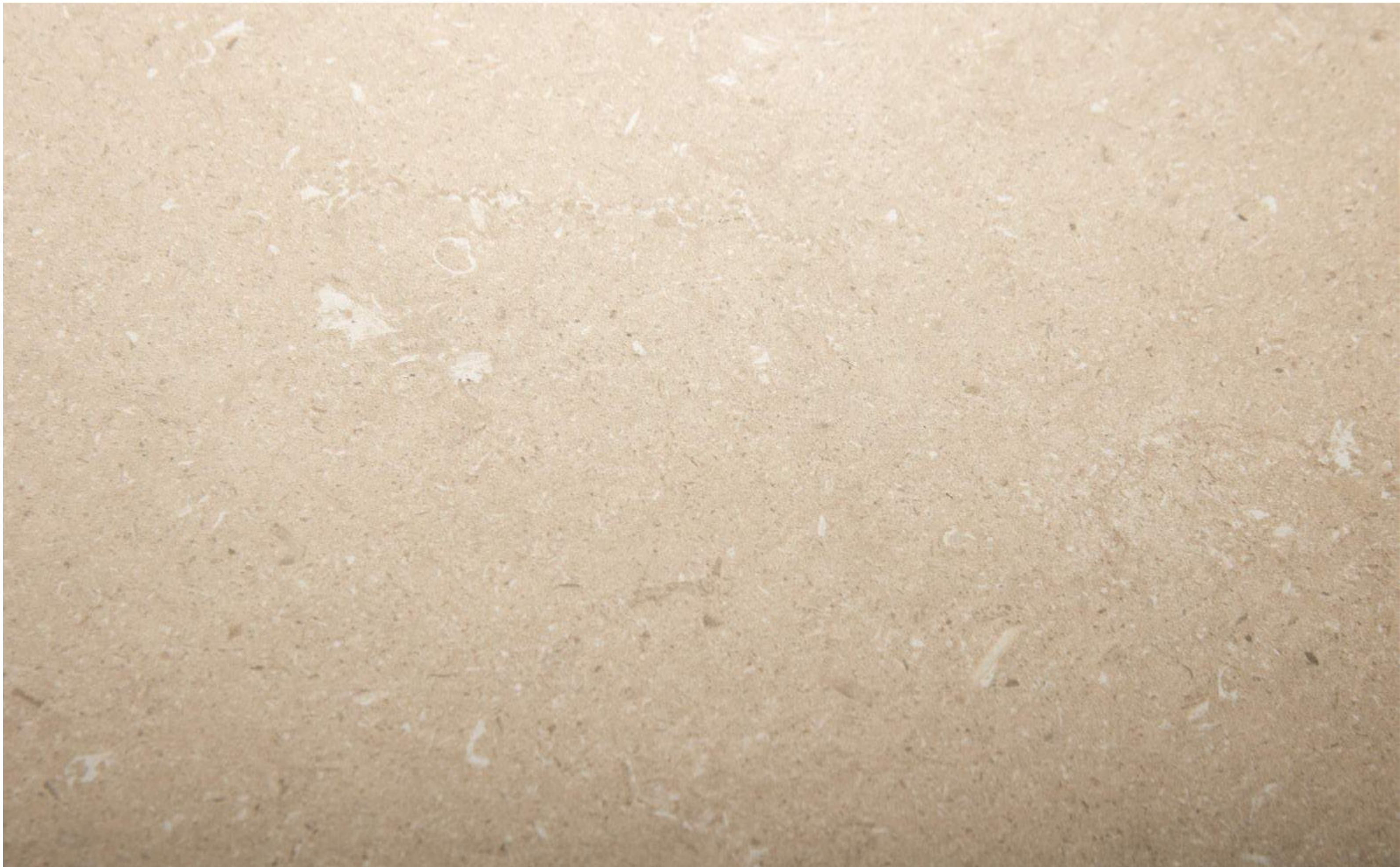

Victorian Stone Limestone Beige natural plus 100x100 cm . 40"x40"

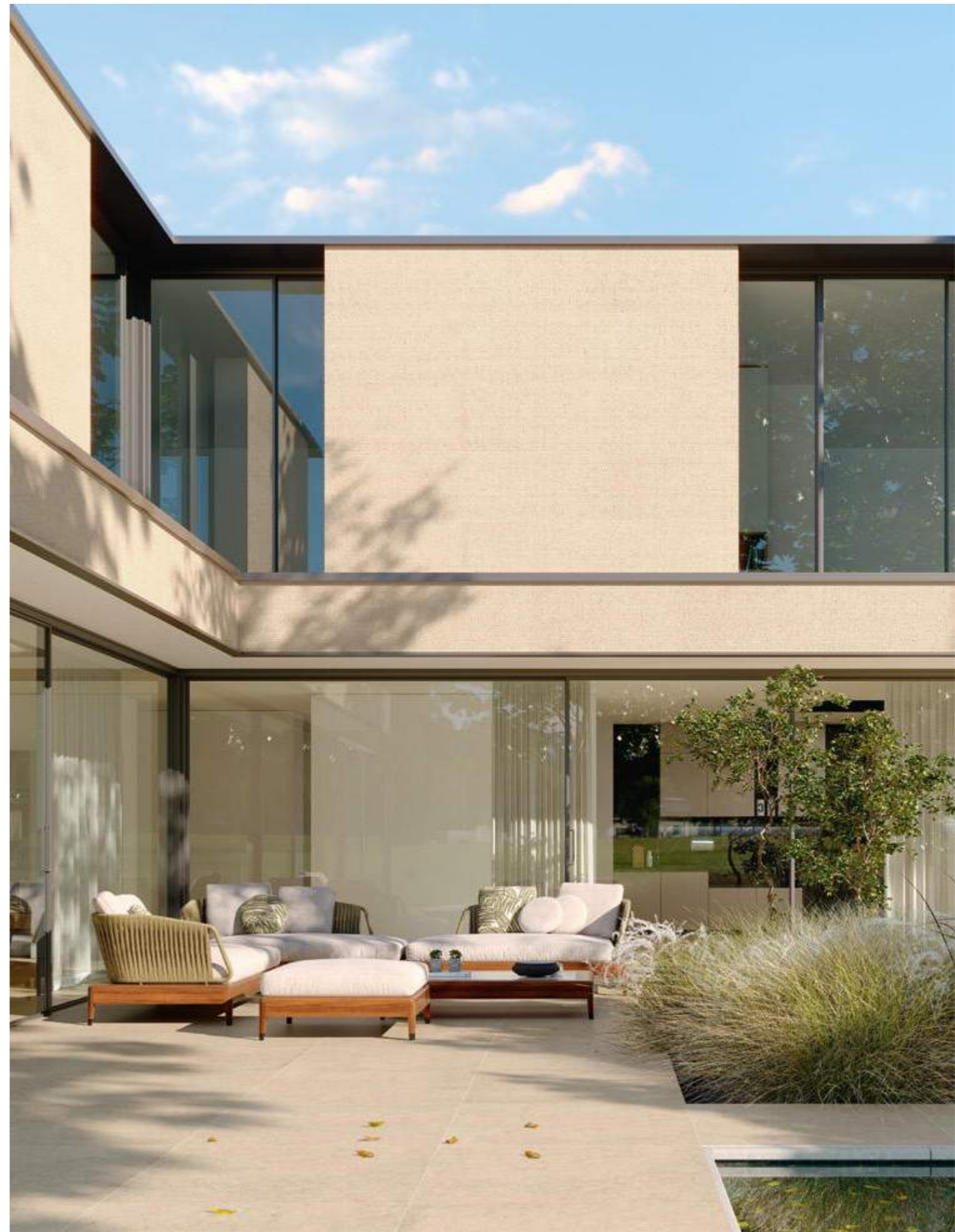

▲ wall: Victorian Stone Limestone Beige structured 120x60 cm . 48"x24" floor: Victorian Stone Limestone Beige antislip 100x100 cm/20mm . 40"x40"/0,79"
◀ Victorian Stone Limestone Beige structured



floor: Victorian Stone Limestone Beige antislip 100x100 cm/20mm . 40"x40"/0,79"



▲ Victorian Stone Moon Cream flamed
▶ wall: Victorian Stone Moon Cream natural plus 120x60 cm . 48"x24" / Black Cliff natural plus 100x100 cm/6mm . 40"x40"/0,24"
▶ floor: Victorian Stone Moon Cream antislip 100x100 cm/20mm . 40"x40"/0,79"



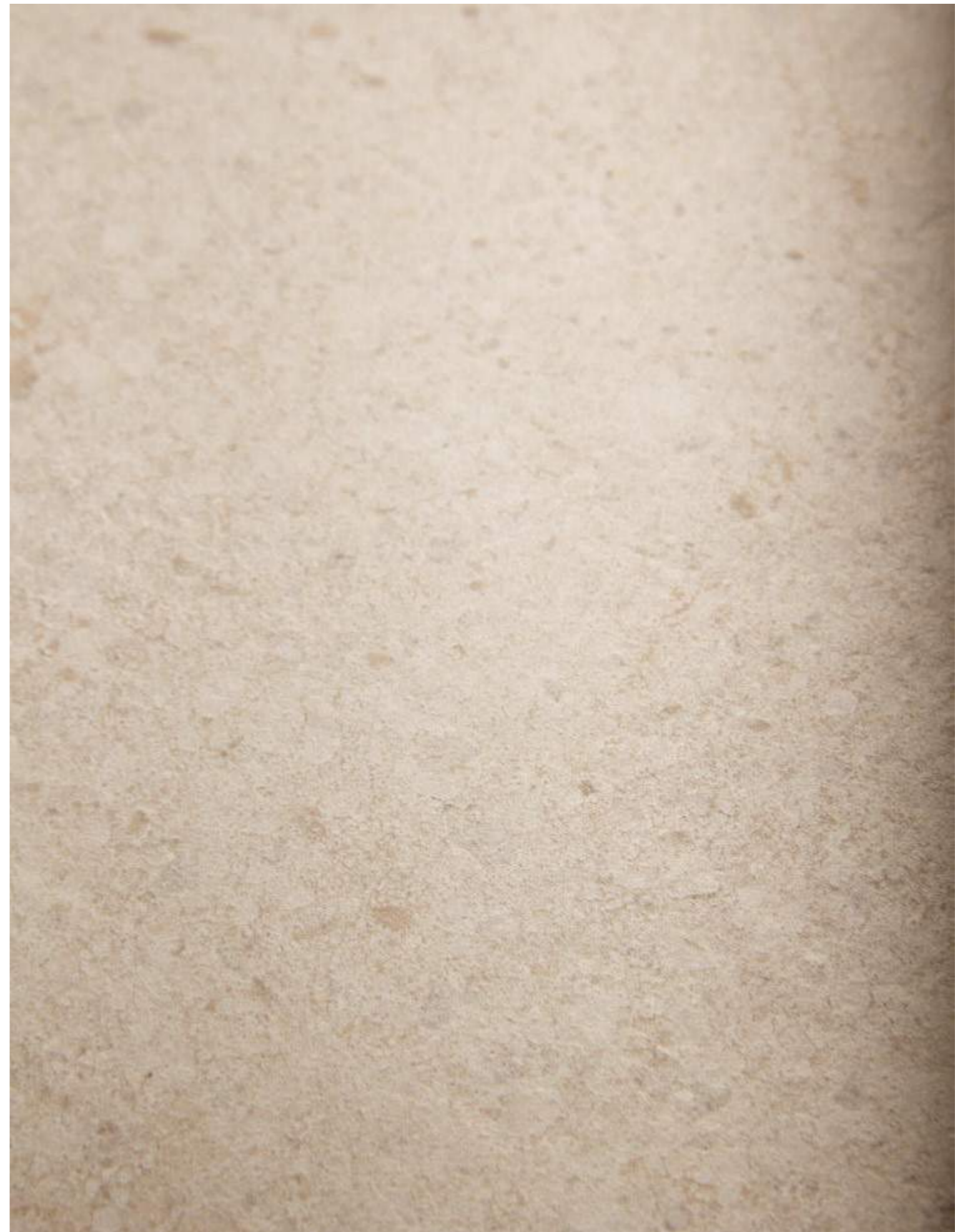

▲ Victorian Stone Moon Cream natural plus
◀ wall: Victorian Stone Silver Grey natural plus 120x60 cm . 48"x24" floor: Victorian Stone Moon Cream natural plus 100x100 cm/6mm . 40"x40"/0,24"



Forest Green natural plus / Baycliff Black natural plus

La superficie Structured riproduce il sapore artigianale di un'antica tecnica di lavorazione della pietra e infonde un raffinato senso di direzionalità longitudinale alla materia. Il risultato è una rivisitazione che permette di personalizzare le pareti coniugando naturalezza e dinamismo.

EN The Structured surface is a tribute to an ancient stone-working technique, infusing the material with a refined sense of longitudinal directionality and an artisanal touch. This reinterpretation allows for a unique personalization of walls, combining the stone's natural essence with a dynamic aesthetic.

FR La surface Structured reproduit la saveur artisanale d'une ancienne technique de travail de la pierre et confère à la matière un sens de directionnalité longitudinale raffiné. Il en résulte une réinterprétation qui permet de personnaliser les murs en alliant naturel et dynamisme.

DE Die Structured-Oberfläche spiegelt den handwerklichen Charakter einer traditionsreichen Steinbearbeitungstechnik wider und verleiht dem Material eine raffinierte Längsausrichtung. Das Ergebnis ist eine Neuinterpretation, die eine individuelle Wandgestaltung ermöglicht und Natürlichkeit mit Dynamik verbindet.

ES La superficie Structured (estructurada) reproduce el sabor artesanal de una antigua técnica de mecanizado de la piedra e infunde a la materia un refinado sentido de direccionalidad longitudinal. El resultado es una reinterpretación que permite personalizar las paredes combinando naturalidad y dinamismo.

RU Поверхность в исполнении Structured передаёт ремесленный дух отделки камня по старинному методу, придавая материалу изысканный вид благодаря продольной направленности. Такой переосмысленный подход позволяет персонализировать стены, выделяя естественность и динамизм.

CH Structured的表面再现了古老石材加工技术的工艺，在材质上加入了考究的横纹。以此铺砌的墙面个性独特，具有天然和动态的效果。



▲ Victorian Stone Baycliff Black structured
▶ wall: Victorian Stone Baycliff Black structured 120x60 cm . 48"x24" floor: Victorian Stone Baycliff Black antislip 120x60 cm . 48"x24"
▶ furniture: Victorian Stone Baycliff Black natural plus





▲ Victorian Stone Forest Green natural plus
◀ wall & floor: Victorian Stone Forest Green natural plus 100x100 cm/6mm . 40"x40"/0,24" furniture: Calacatta Oro lucido



▲ Victorian Stone Baycliff Black flamed
▶ wall & shower floor: Victorian Stone Baycliff Black flamed 120x60 cm . 48"x24" floor: Victorian Stone Baycliff Black antislip 120x60 cm . 48"x24"





▲ Victorian Stone Limestone Beige structured
◀ wall: Victorian Stone Limestone Beige flamed 120x60 cm . 48"x24" floor: Victorian Stone Limestone Beige antislip 60x60 cm . 24"x24"

Con la finitura Flamed, ispirata alle antiche operazioni di bocciardatura, le superfici per interni ed esterni acquistano una sorprendente morbidezza tattile e visiva. Una sensazione che dona armonia all'insieme e accresce le sensazioni di comfort degli spazi.

EN The Flamed finish, inspired by the traditional bush-hammering method, imparts a surprising tactile and visual softness to both interior and exterior surfaces. This enhances the harmony of the environment, elevating the overall sense of comfort in the space.

FR La finition Flamed, inspirée par les anciennes opérations de bouchardage, confère aux surfaces pour intérieurs et extérieurs une douceur tactile et visuelle surprenante. Une sensation qui rend l'ensemble harmonieux et accentue le sentiment de confort des espaces.

DE Mit dem Flame-Finish, inspiriert durch die antiken Techniken des Stockhämmerns, erhalten die Oberflächen im Innen- und Außenbereich eine überraschende taktile und visuelle Weichheit. Eine Empfindung, die dem Ganzen Harmonie verleiht und das Gefühl der Behaglichkeit in Räumen verstärkt.

ES Con el acabado Flameado (Flamed), inspirado en las antiguas operaciones de abujardado, las superficies interiores y exteriores adquieren una sorprendente suavidad táctil y visual. Una sensación que brinda armonía al conjunto y aumenta la sensación de confort en los espacios.

RU Отделка в исполнении Flamed имитирует старинную технику бучардирования: после такой обработки внутренние и наружные поверхности приобретают визуальную и тактильную мягкость. Благодаря этому всё в интерьере гармонирует между собой, создавая комфорт и уют.

CH 而Flamed饰面的灵感来自古老的石材捶打技术,让室内室外表面在视觉和触感上呈现出人意表的柔和感。赋予整体和谐效果,提升空间舒适感。



Victorian Stone Silver Grey flamed



▲ Victorian Stone Silver Grey natural plus
▶ wall: Victorian Stone Baycliff Black natural plus 60x30 cm . 24"x12" floor: Victorian Stone Silver Grey natural plus 100x100 cm/6mm . 40"x40"/0,24"





floor: Victorian Stone Silver Grey natural plus 100x100 cm/6mm . 40"x40"/0,24"



▲ wall: Victorian Stone Limestone Beige structured 120x60 cm . 48"x24"
◀ wall: Victorian Stone Limestone Beige structured 120x60 cm . 48"x24"
◀ floor: Victorian Stone Limestone Beige natural plus 100x100 cm/6mm . 40"x40"/0,24" furniture: FMG Brown Fusion



floor: Victorian Stone Baycliff Black natural plus 100x100 cm/6mm . 40"x40"/0,24"



▲ Victorian Stone Baycliff Black natural plus
▶ floor: Victorian Stone Baycliff Black natural plus 100x100 cm/6mm . 40"x40"/0,24"





wall: Victorian Stone Moon Cream natural 270x120 cm . 106"x48" floor: Victorian Stone Moon Cream natural plus 120x120 cm . 48"x48"

Con i due nuovi formati di grandi dimensioni 120x120 e 120x270 cm - che si affiancano alle varianti già presenti - la materia ispiratrice esprime appieno il suo potenziale visivo. E il respiro compositivo si fa ancora più esteso, aprendo la strada a molteplici soluzioni dal grande impatto scenico e progettuale.

EN Two new large formats, 120x120 cm and 120x270 cm, have been added to the existing range to maximize the visual appeal of the inspirational material. The compositional possibilities are now endless, offering a wide spectrum of solutions with a striking scenic and design effect.

FR Avec deux nouveaux grands formats (120x120 cm et 120x270 cm) qui s'ajoutent à ceux déjà présents, la matière d'inspiration exprime pleinement son potentiel visuel. Ainsi, les possibilités de composition se multiplient, ouvrant la voie à de nombreuses solutions à l'impact scénique et conceptuel remarquable.

DE Mit den beiden neuen Großformaten 120x120 und 120x270 cm, die die bereits vorhandenen Varianten ergänzen, entfaltet das inspirierende Material sein volles visuelles Potenzial. Die kompositorische Eingebung wird noch weiter erfasst und ebnet den Weg für vielfältige Lösungen mit großer szenischer und gestalterischer Wirkung.

ES Con los dos nuevos formatos de tamaño grande 120x120 y 120x270 cm -que se suman a las variantes ya existentes- la materia inspiradora expresa plenamente su potencial visual. El alcance compositivo se extiende aún más, abriendo camino a numerosas soluciones de gran impacto escénico y proyectual.

RU Наряду с уже имеющимися вариантами появились два новых крупногабаритных формата 120x120 см и 120x270 см: теперь материя станет богатым источником вдохновения и позволит раскрыть весь визуальный потенциал. Это также расширяет возможности комбинирования, открывая путь к множеству эффектных решений по оформлению и проектированию.

CH 两款全新大型规格 120x120 和 120x270cm, 丰富了现有系列, 让这种激发灵感材料充分表达其视觉潜力。组合方式进一步拓展, 为多种解决方案开辟道路, 创造令人惊叹的景观和设计效果。



wall in: Victorian Stone Moon Cream natural 270x120 cm . 106"x48" **wall out:** Victorian Stone Moon Cream structured 120x60 cm . 48"x24"
floor in: Victorian Stone Moon Cream natural plus 120x120 cm . 48"x48" **floor out:** Armonie Legno Rovere Primavera antislip 120x20 cm . 48"x8"



▲ wall: Victorian Stone Silver Grey natural 270x120 cm . 106"x48" floor: Victorian Stone Silver Grey natural plus 120x120 cm . 48"x48"
◀ wall: Victorian Stone Limestone Beige natural 270x120 cm . 106"x48" floor: Victorian Stone Limestone Beige natural plus 120x120 cm . 48"x48"

Il potenziale di Victorian Stone trova ulteriore slancio con una proposta di rivestimenti in pasta bianca nel formato 120x40, disponibili in tutti i colori e nelle quattro strutture 3d Tide, Domino, Line e Shade. Un concentrato di tecnologia e sensibilità decorativa, attentamente studiato per animare le pareti con accattivanti effetti scultorei e proporre ricercati dialoghi con le altre superfici effetto pietra.

EN The potential of Victorian Stone is fully unleashed with a selection of White Body wall coverings measuring 120x40 cm, offered in a variety of colors and four distinct 3D structures: Tide, Domino, Line, and Shade. This blend of technology and design sensitivity is meticulously crafted to create intriguing sculptural effects on walls and allow for sophisticated combinations with other stone-effect surfaces.

FR Le potentiel de Victorian Stone s'exprime pleinement grâce à une proposition de revêtements en White Body (pâte blanche), dans le format 120x40 cm, disponibles dans toutes les couleurs et dans les quatre structures 3d Tide, Domino, Line et Shade. Un concentré de technologie et de sensibilité décorative, soigneusement pensé pour animer les murs grâce à de fascinants effets sculpturaux et pour proposer des dialogues raffinés avec les autres surfaces effet pierre.

DE Das Potenzial von Victorian Stone wird durch ein Angebot an Feinsteinzeugoberflächen in White Body (Pasta Bianca) im Format 120x40 weiter verstärkt. Die Kollektion ist in allen Farben und in den vier 3D-Strukturen Tide, Domino, Line und Shade erhältlich. Ein Konzentrat aus Technologie und dekorativem Gespür, sorgfältig entwickelt, um Wände mit faszinierenden skulpturalen Effekten zu beleben und raffinierte Dialoge mit anderen Oberflächen in Steinoptik zu schaffen.

ES El potencial de Victorian Stone adquiere aún más impulso con una propuesta de revestimientos en White Body (pasta blanca) en el formato de 120x40, disponibles en todos los colores y en las cuatro estructuras 3d Tide, Domino, Line y Shade. Un concentrado de tecnología y sensibilidad decorativa, atentamente estudiado para animar las paredes con cautivadores efectos escultóricos y proponer refinadas combinaciones con las otras superficies efecto piedra.

RU Коллекция Victorian Stone открывает новые возможности для реализации потенциала благодаря облицовке White Body (белая плитка) формата 120x40, доступной во всех цветах и в четырех структурах 3D Tide, Domino, Line и Shade. В ней сконцентрированы технологии и сенсорный декор, тщательно подобранные для воссоздания на стенах захватывающего эффекта скульптуры и изысканного сочетания с другими поверхностями под камень.

CH Victorian Stone 的潜力得到了进一步发挥, 推出一系列规格为120x40厘米的白色墙砖, 提供多种颜色和四种3D纹理: 潮汐纹、多米诺纹、线条纹和阴影纹。融合科技与装饰感, 经过精心设计, 赋予墙面迷人的雕塑效果, 与其他石材效果表面相得益彰。



wall: Victorian Stone Domino Limestone Beige natural structured 40x120 cm . 48"x16"



wall: Victorian Stone Domino Limestone Beige natural structured 40x120 cm . 48"x16"
floor: Victorian Stone Limestone Beige natural plus 120x120 cm . 48"x48"



▲ wall: Victorian Stone Line White natural structured 120x40 cm . 48"x16"
▶ wall: Victorian Stone Limestone Beige natural 270x120 cm . 106"x48", Line White natural structured 120x40 cm . 48"x16"
floor: Victorian Stone Limestone Beige natural plus 120x120 cm . 48"x48"



▲ wall: Victorian Stone Moon Cream natural 270x120 cm . 106"x48", Line Green natural structured 120x40 cm . 48"x16"
◀ wall: Victorian Stone Moon Cream natural 270x120 cm . 106"x48", Line Green natural structured 120x40 cm . 48"x16"
floor: Victorian Stone Forest Green natural plus 120x120 cm . 48"x48"



▲ wall: Victorian Stone Shade Grey natural structured 120x40 cm . 48"x16"
▶ wall: Victorian Stone Shade Grey natural structured 120x40 cm . 48"x16" floor: Victorian Stone Silver Grey natural plus 120x120 cm . 48"x48"

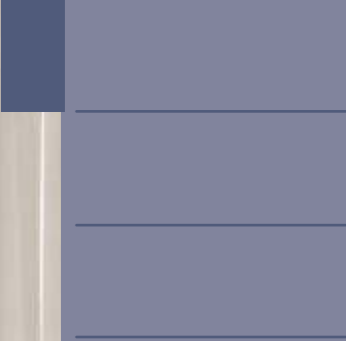



▲ wall: Victorian Stone Shade Beige natural structured 120x40 cm . 48"x16", Moon Cream natural 120x40 cm . 48"x16"
◀ wall: Victorian Stone Shade Beige natural structured 120x40 cm . 48"x16", Moon Cream natural 120x40 cm . 48"x16"
floor: Victorian Stone Moon Cream natural plus 120x120 cm . 48"x48"



▲ wall: Victorian Stone Tide Beige natural structured 120x40 cm . 48"x16"
▶ wall: Victorian Stone Tide Beige natural structured 120x40 cm . 48"x16", Limestone Beige natural 120x40 cm . 48"x16"
floor: Victorian Stone Limestone Beige natural plus 120x120 cm . 48"x48"

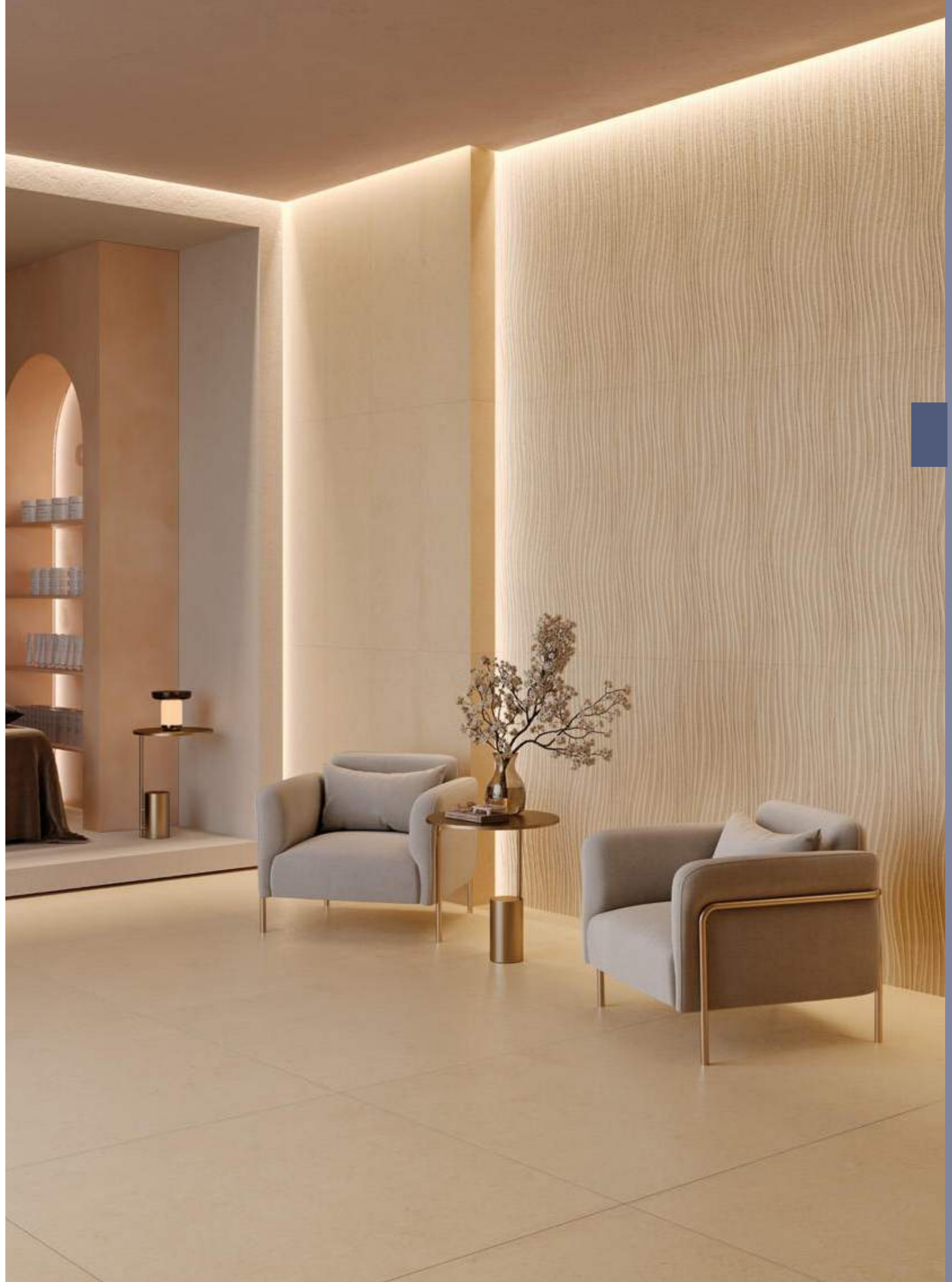



floor in: Victorian Stone Silver Grey natural plus 120x60 cm . 48"x24" floor out: Victorian Stone Silver Grey antislip 120x60 cm/20mm . 48"x24"/0,79"

Con il nuovo formato 120x60 cm a spessore di 20 mm, declinato nelle raffinate tonalità Moon Cream, Limestone Beige e Silver Grey, si aprono nuove prospettive progettuali per dare forma a spazi outdoor ricchi di fascino. Una soluzione capace di esaltare la naturale eleganza della pietra e creare ambienti fluidi, dove interni ed esterni dialogano in perfetta sintonia.

EN Measuring 120x60 cm and 20 mm in thickness, the new format opens up a whole new world of design possibilities for aesthetically pleasing outdoor spaces. It is available in three sophisticated colors: Moon Cream, Limestone Beige, and Silver Grey. This solution brings out the natural elegance of stone, creating fluid environments with seamless transitions between indoor and outdoor spaces.

FR Le nouveau format 120x60 cm avec une épaisseur de 20 mm, décliné dans les tonalités raffinées Moon Cream, Limestone Beige et Silver Grey, offre de nouvelles perspectives conceptuelles, pour donner forme à des espaces extérieurs pleins de charme. Une solution en mesure d'exalter l'élégance naturelle de la pierre et de créer des espaces fluides, où l'intérieur et l'extérieur dialoguent en parfaite syntonie.

DE Mit dem neuen Format 120x60 cm und einer Stärke von 20 mm eröffnen sich in den eleganten Farbtönen Moon Cream, Limestone Beige und Silver Grey neue Gestaltungsmöglichkeiten für faszinierende Außenbereiche. Eine Lösung, die die natürliche Eleganz des Steins unterstreicht und fließende Räume schafft, in denen Innen und Außen in perfekter Harmonie miteinander kommunizieren.

ES Con el nuevo formato 120x60 cm de 20 mm de espesor, declinado en los refinados tonos Moon Cream, Limestone Beige y Silver Grey, se abren nuevas perspectivas proyectuales para dar forma a espacios exteriores sumamente atractivos. Una solución capaz de exaltar la elegancia natural de la piedra y crear ambientes fluidos, donde los interiores y los exteriores dialogan en perfecta sintonía.

RU Новый формат 120x60 см с толщиной 20 мм, доступный в изысканных оттенках Moon Cream, Limestone Beige и Silver Grey, открывает перед дизайнерами новые горизонты в оформлении уличной зоны с эстетически привлекательным обликом. Это решение способно подчеркнуть природную элегантность камня и внести динамику в пространство, гармонично совмещая интерьер и экстерьер.

CH 全新的120x60厘米规格,厚度20毫米,提供月光乳白、石灰米白和银灰色等精致色调,为打造迷人的户外空间开辟了新的设计前景。这一解决方案能够彰显石材的自然优雅,营造自然流动的环境,使室内外完美和谐地交融。



▲ floor in: Victorian Stone Silver Grey natural plus 120x60 cm . 48"x24" floor out: Victorian Stone Silver Grey antislip 120x60 cm/20mm . 48"x24"/0,79"
 ► floor in: Victorian Stone Limestone Beige natural plus 120x60 cm . 48"x24" floor out: Victorian Stone Limestone Beige antislip 120x60 cm/20mm . 48"x24"/0,79"

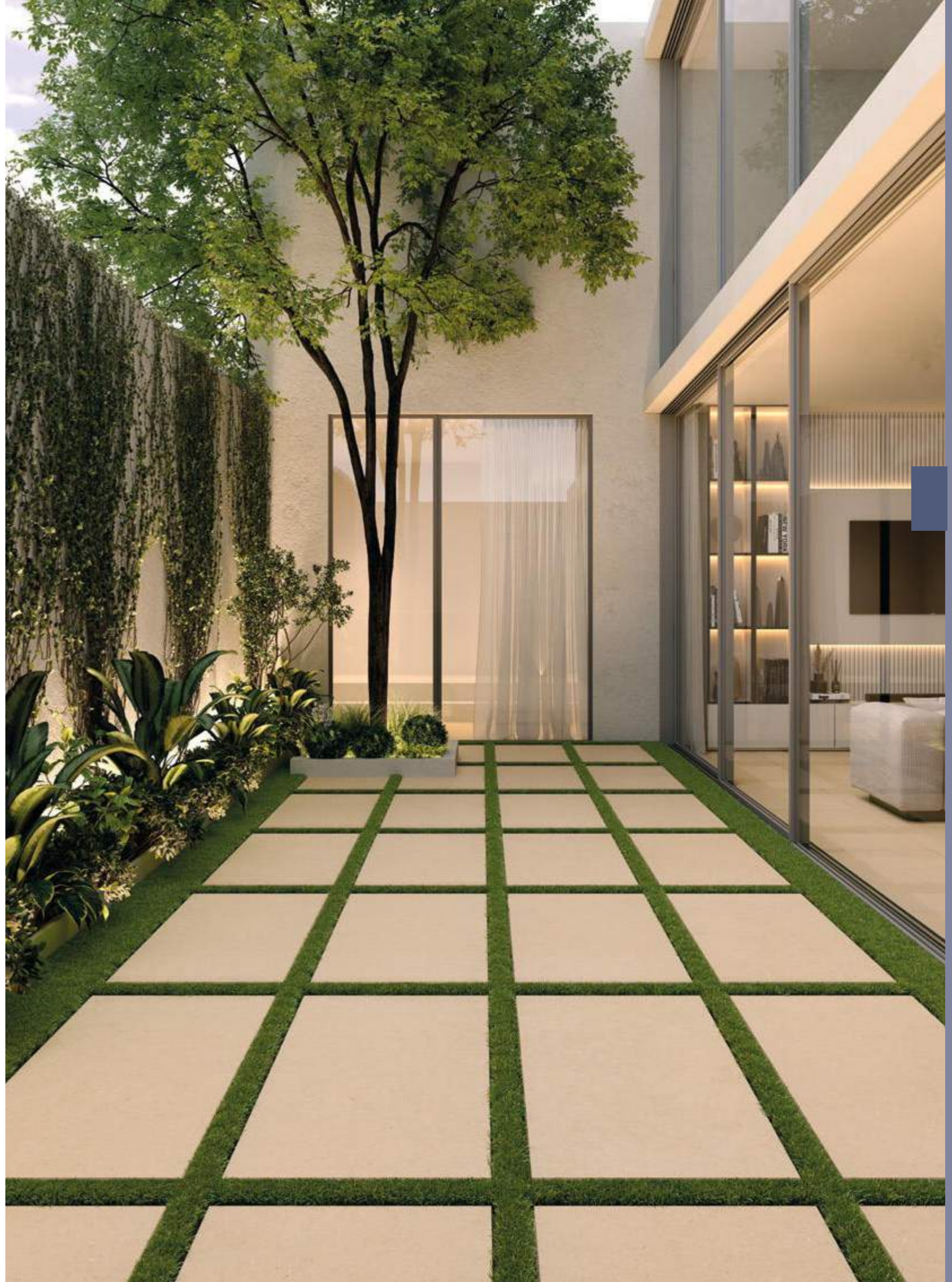



Specifiche tecniche

Tech and specs • Spécifications techniques
Technische spezifikationen • Especificaciones técnicas
Технические характеристики • 技術規格

Grès porcellanato 66 Porcelain stoneware

MOON CREAM 66

LIMESTONE BEIGE 67

SILVER GREY 68

BAYCLIFF BLACK 69

FOREST GREEN 70

Pezzi speciali 71 Trims

Rivestimenti 72 Wall surfaces

Safe System 74

Imballi 75 Packing

Caratteristiche tecniche 76 Technical characteristics









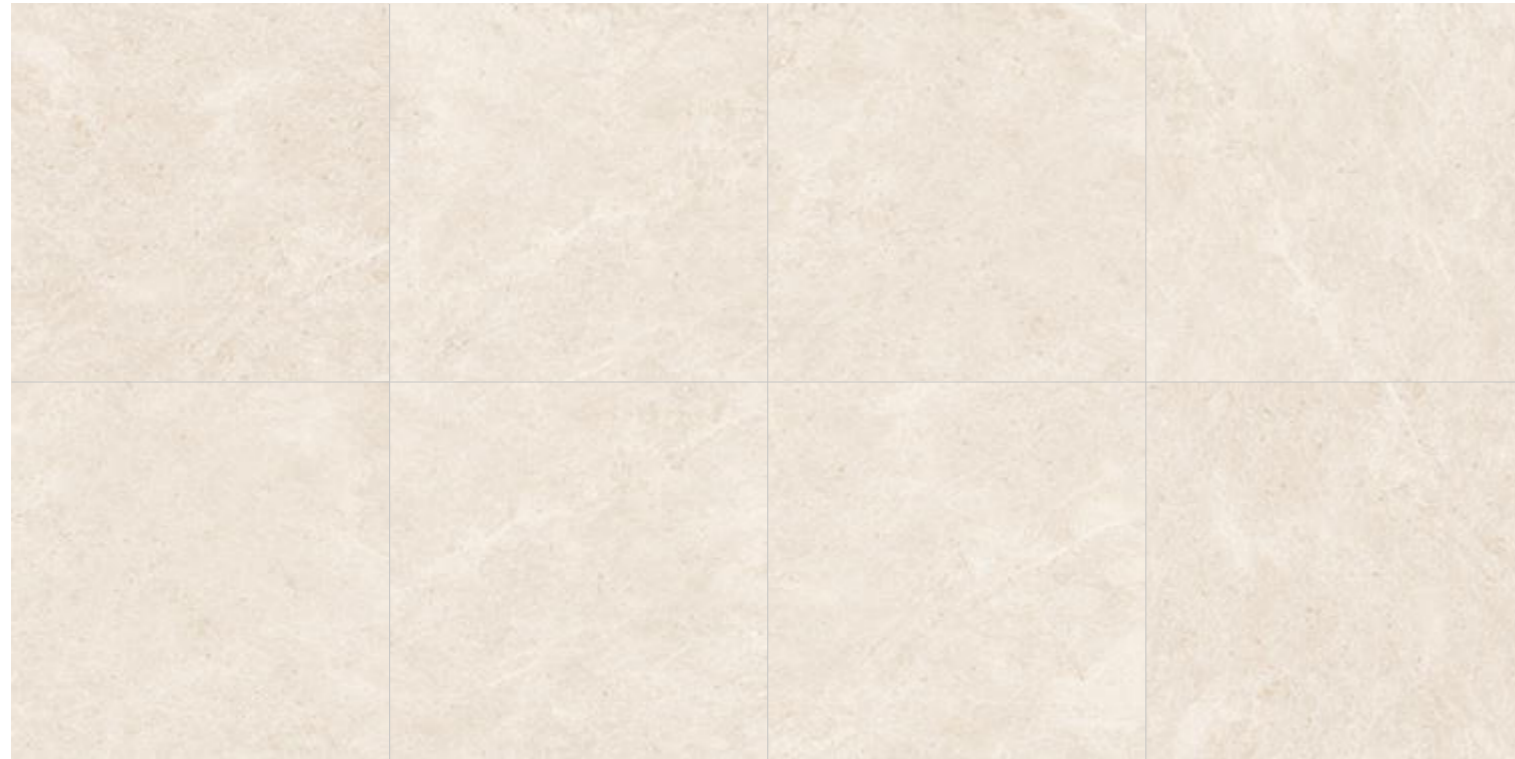







VICTORIAN STONE

270x120 cm . 100x100 cm Spessore 6 mm | 106"x48" . 40"x40" Thickness 0,24"
 120x120 cm . 120x60 cm . 60x60 cm . 60x30 cm Spessore 8 mm | 48"x48" . 48"x24" . 24"x24" . 24"x12" Thickness 0,31"
 100x100 cm . 120x60 cm Spessore 20 mm | 40"x40" . 48"x24" Thickness 0,79"
 Grès porcellanato . Porcelain stoneware . Grès cérame . Feinsteinzeug . Gres porcelánico . Керамогранит . 上釉系列

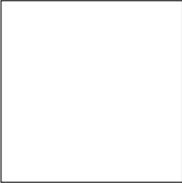

















MOON CREAM



		
270x120/6mm . 106"x48"/0,24" 	120x60/20mm . 48"x24"/0,79" 	120x60 . 48"x24" 
Moon Cream Natural HI2712053XL	Moon Cream Antislip 892999520	Moon Cream Natural Plus Moon Cream Structured Moon Cream Flamed 8929994 8929984 8929989
		
100x100/20mm . 40"x40"/0,79" 	60x60 . 24"x24" 	
Moon Cream Antislip 1009999	Moon Cream Natural Plus Moon Cream Flamed Moon Cream Antislip 8669994 8669989 8669999	
		
120x120 . 48"x48" 	100x100/6mm . 40"x40"/0,24" 	60x30 . 24"x12" 
Moon Cream Natural Plus 1209994	Moon Cream Natural Plus 1009994	Moon Cream Natural Plus Moon Cream Structured Moon Cream Flamed 8639994 8639984 8639989

LIMESTONE BEIGE



		
270x120/6mm . 106"x48"/0,24" 	120x60/20mm . 48"x24"/0,79" 	120x60 . 48"x24" 
Limestone Beige Natural HI2712052XL	Limestone Beige Antislip 8929998520	Limestone Beige Natural Plus Limestone Beige Structured Limestone Beige Flamed 8929993 8929983 8929988
		
100x100/20mm . 40"x40"/0,79" 	60x60 . 24"x24" 	
Limestone Beige Antislip 1009998	Limestone Beige Natural Plus Limestone Beige Flamed Limestone Beige Antislip 8669993 8669988 8669998	
		
120x120 . 48"x48" 	100x100/6mm . 40"x40"/0,24" 	60x30 . 24"x12" 
Limestone Beige Natural Plus 1209993	Limestone Beige Natural Plus 1009993	Limestone Beige Natural Plus Limestone Beige Structured Limestone Beige Flamed 8639993 8639983 8639988

VICTORIAN STONE

270x120 cm . 100x100 cm Spessore 6 mm | 106"x48" . 40"x40" Thickness 0,24"
 120x120 cm . 120x60 cm . 60x60 cm . 60x30 cm Spessore 8 mm | 48"x48" . 48"x24" . 24"x24" . 24"x12" Thickness 0,31"
 100x100 cm . 120x60 cm Spessore 20 mm | 40"x40" . 48"x24" Thickness 0,79"
 Grès porcellanato . Porcelain stoneware . Grès cérame . Feinsteinzeug . Gres porcelánico . Керамогранит . 上釉系列





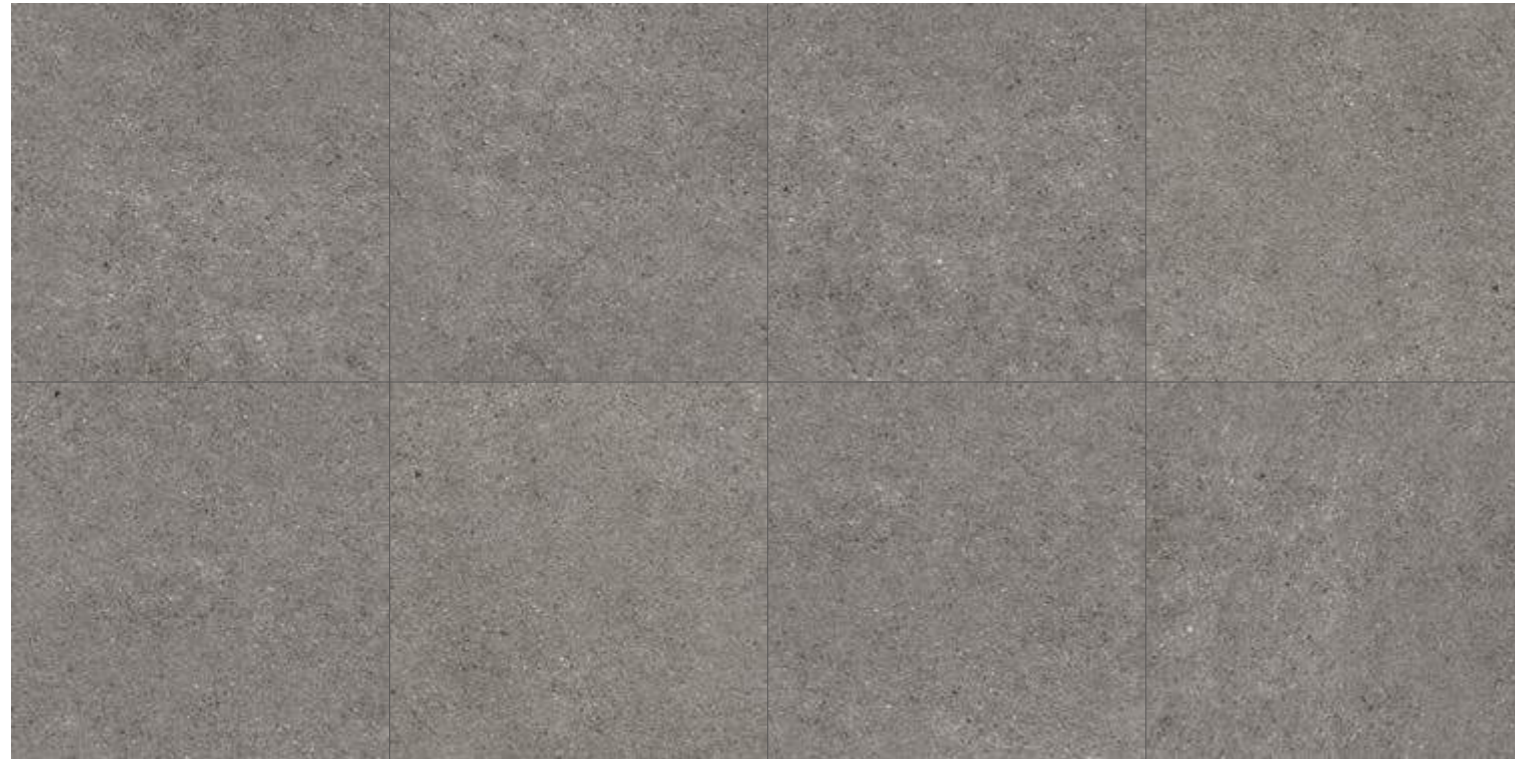



SILVER GREY



		
270x120/6mm . 106"x48"/0,24" Silver Grey Natural 1209991	120x60/20mm . 48"x24"/0,79" Silver Grey Antislip 8929996520	120x60 . 48"x24" Silver Grey Natural Plus Silver Grey Structured Silver Grey Flamed 8929991 8929981 8929986
		
100x100/20mm . 40"x40"/0,79" Silver Grey Antislip 1009996	60x60 . 24"x24" Silver Grey Natural Plus Silver Grey Flamed Silver Grey Antislip 8669991 8669986 8669996	60x60 . 24"x24" Silver Grey Natural Plus Silver Grey Structured Silver Grey Flamed 8639991 8639981 8639986
		
120x120 . 48"x48" Silver Grey Natural Plus 1209991	100x100/6mm . 40"x40"/0,24" Silver Grey Natural Plus 1009991	60x30 . 24"x12" Silver Grey Natural Plus Silver Grey Structured Silver Grey Flamed 8639991 8639981 8639986

BAYCLIFF BLACK



		
120x60 . 48"x24" Baycliff Black Natural Plus Baycliff Black Structured Baycliff Black Flamed 8929990 8929980 8929985	100x100/20mm . 40"x40"/0,79" Baycliff Black Antislip 1009995	60x60 . 24"x24" Baycliff Black Natural Plus Baycliff Black Flamed Baycliff Black Antislip 8669990 8669985 8669995
		
120x120 . 48"x48" Baycliff Black Natural Plus 1209990	100x100/6mm . 40"x40"/0,24" Baycliff Black Natural Plus 1009990	60x30 . 24"x12" Baycliff Black Natural Plus Baycliff Black Structured Baycliff Black Flamed 8639990 8639980 8639985

VICTORIAN STONE



270x120 cm . 100x100 cm Spessore 6 mm | 106"x48" . 40"x40" Thickness 0,24"
 120x120 cm . 120x60 cm . 60x60 cm . 60x30 cm Spessore 8 mm | 48"x48" . 48"x24" . 24"x24" . 24"x12" Thickness 0,31"
 100x100 cm . 120x60 cm Spessore 20 mm | 40"x40" . 48"x24" Thickness 0,79"
 Grès porcellanato . Porcelain stoneware . Grès cérame . Feinsteinzeug . Gres porcelánico . Керамогранит . 上釉系列







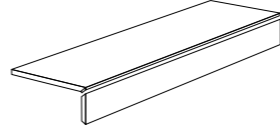







FOREST GREEN



Pezzi speciali . Trims . Pièces spéciales . Formstücke . Piezas especiales . Специальные элементы . 鑲邊

		
	GRADINO L JOLLY *	BATTISCOPA
	120x30 Natural Plus	6,5x60 Natural Plus
		
MOON CREAM	DISPONIBILE SOLO SU RICHIESTA AVAILABLE ONLY ON REQUEST	6569994
LIMESTONE BEIGE		6569993
SILVER GREY		6569991
BAYCLIFF BLACK		6569990
FOREST GREEN		6569992

* Realizzati in 2 pezzi assemblati . Produced in 2 assembled pieces . Réalisés par l'assemblage de 2 pièces
 Realizados en 2 piezas ensambladas . Выполнено из 2 смонтированных частей . 由2个组件组成

		120x60 . 48"x24"		8929992 8929982 8929987
		Forest Green Natural Plus Forest Green Structured Forest Green Flamed		
		100x100/20mm . 40"x40"/0,79"		1009997
		Forest Green Antislip		
		60x60 . 24"x24"		8669992 8669987 8669997
		Forest Green Natural Plus Forest Green Flamed Forest Green Antislip		
		120x120 . 48"x48"		1209992
Forest Green Natural Plus				
		100x100/6mm . 40"x40"/0,24"		1009992
		Forest Green Natural Plus		
		60x30 . 24"x12"		8639992 8639982 8639987
		Forest Green Natural Plus Forest Green Structured Forest Green Flamed		

VICTORIAN STONE

120x40 cm Spessore 8,5 mm | 48"x16" Thickness 0,33"



(WHITE BODY) Rivestimenti . Wall surfaces . Revêtements . Wandfliesen . Revestimientos . Плитка Для Стен . 牆面瓷磚



Moon Cream Natural **12140040**



Limestone Beige Natural **12140039**



Silver Grey Natural **12140037**



Baycliff Black Natural **12140036**



Forest Green Natural **12140038**

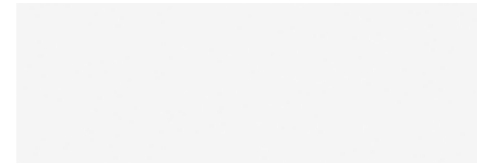

Full White Natural **12140053**

VICTORIAN STONE

120x40 cm Spessore 10 mm | 48"x16" Thickness 0,39"



(WHITE BODY) Rivestimenti . Wall surfaces . Revêtements . Wandfliesen . Revestimientos . Плитка Для Стен . 牆面瓷磚

LINE

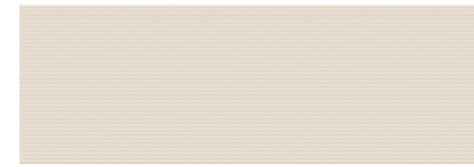

Cream Natural Structured **12140047L**



Beige Natural Structured **12140046L**



Grey Natural Structured **12140044L**



Black Natural Structured **12140043L**



Green Natural Structured **12140045L**

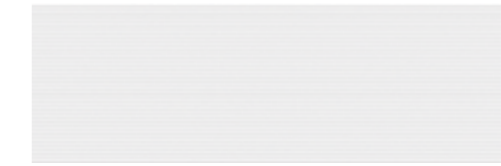

White Natural Structured **12140048L**

DOMINO



Moon Cream Natural Structured **12140040D**



Limestone Beige Natural Structured **12140039D**

TIDE



Moon Cream Natural Structured **12140040T**



Limestone Beige Natural Structured **12140039T**

SHADE

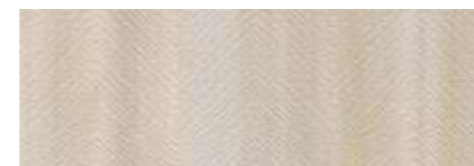

Beige Natural Structured **12140042S**



Grey Natural Structured **12140041S**

SAFE SYSTEM

Classificazione resistenza allo scivolamento DIN EN 16165-ANNEX B (ex DIN 51130) . Slip resistance classification DIN EN 16165-ANNEX B (ex DIN 51130) . Klassifizierung der rutschfestigkeit DIN EN 16165-ANNEX B (ex DIN 51130) . Résistance au glissement DIN EN 16165-ANNEX B (ex DIN 51130) . Clasificación resistencia al deslizamiento DIN EN 16165-ANNEX B (ex DIN 51130) . Классификация сопротивления подскользыванию DIN EN 16165-ANNEX B (ex DIN 51130) . 防滑等级 DIN EN 16165-ANNEX B (ex DIN 51130)

COLLEZIONE COLLECTION KOLLEKTION COLLECTION COLECCIÓN КОЛЛЕКЦИЯ 系列	FINITURA FINISH OBERFLÄCHEN AUSFÜHRUNG FINITION ACABADO ОТДЕЛКА 饰面		
	NATURAL	R9	
	NATURAL PLUS	R10 A+B	
VICTORIAN STONE	STRUCTURED	R10 A+B	
	FLAMED	R10 A+B	
	ANTISLIP	R11 A+B+C	

Grado di variazione cromatica. Degree of colour change. Grad der farbabweichung .
Degre de variation chromatique. Grado de variación cromática. Степень изменения цвета. 变色度

COLLEZIONE COLLECTION KOLLEKTION COLLECTION COLECCIÓN КОЛЛЕКЦИЯ 系列			
VICTORIAN STONE	FLOOR	V3	
VICTORIAN STONE	WALL	V3	

V1 - LOW.
Prodotto monochromatico . Monochromatic product
Produit monochromatique. Einfarbiges produkt
Producto monocrómico. Одноцветный продукт
单色产品

V2 - MODERATE.
Prodotto con leggera variazione cromatica. Product with light chromatic variation
Produit à légère variation chromatique. Produkt mit leichter farbnance
Producto con una ligera variación cromática. Продукт с легкими изменениями оттенков
轻微变色的产品

V3 - HIGH.
Prodotto con marcata variazione cromatica. Product with high shade chromatic variation
Produit à variation chromatique accentuée. Produkt mit ausgeprägter farbnance
Producto con una marcada variación cromática. Продукт с выраженными изменениями цвета
高度变色的产品

V4 - EXTREME.
Prodotto con forte variazione cromatica. Product with very high shade chromatic variation
Produit à forte variation chromatique. Produkt mit starker farbnance
Producto con una fuerte variación cromática. Продукт с сильными изменениями цвета
高度变色的产品

R9 6° - 10° **R10 10° - 19°** **R11 19° - 27°**

N.B: I valori di resistenza allo scivolamento, coefficiente di attrito statico o dinamico, riportati sul catalogo e nella tabella Safe System sono da ritenersi puramente indicativi e non vincolanti. Ogni eventuale specifica necessità dovrà essere da noi confermata al momento dell'ordine e comunque sempre prima della posa.

N.B: Slip resistance values, coefficient of static or dynamic friction, in the catalog and in the Safe System Table are purely indicative and not binding. Any specific requirements must be confirmed by us at the time of ordering and in any case before installation.

ANM.: Die Werte für die Rutschfestigkeit, also des statischen oder dynamischen Reibungskoeffizienten, die im Katalog oder in der Tabelle Safe System aufgeführt sind, sind als unverbindliche Richtwerte anzusehen. Alle spezifischen Anforderungen müssen von uns bei der Bestellung und in jedem Fall vor der Verlegung immer bestätigt werden.

N.B: Les valeurs de résistance au glissement, le coefficient de frottement statique ou dynamique, indiqués sur le catalogue et sur le tableau Safe System (Système de Sécurité) doivent être considérés comme purement indicatifs et ne sauraient engager notre responsabilité. Toutes les éventuelles spécifications nécessaires devront faire l'objet d'une confirmation de notre part au moment de la commande et en tout état de cause avant la pose.

N.B.: Los valores de resistencia al deslizamiento y del coeficiente de fricción estático o dinámico que figuran en el catálogo y en la tabla Safe System (Sistema de Seguridad) son meramente informativos y no vinculantes. Cualquier requisito específico tendremos que confirmarlo al realizar el pedido y, en cualquier caso, antes de la colocación.

Примечание: значения сопротивления подскользыванию, коэффициент статического или динамического трения в каталоге и в таблице безопасных систем являются исключительно ориентировочными и не имеют обязательной силы. Любые конкретные требования должны быть подтверждены нами во время заказа и в любом случае перед установкой.

备注: 目录和《安全系统》表中报告的防滑性, 静态或动态摩擦系数数值仅供参考且不具有约束力。任何特定需求必须在订购时由我们确认, 且必须在铺设之前确认。

PACKING

Imballi . Packing . Conditionnement . Verpackungseinheiten . Embalajes . Упаковка . 包装

Grès porcellanato . Porcelain stoneware . Grès cérame . Feinsteinzeug . Gres porcelánico . Керамогранит . 上釉系列

FORMATO SIZE FORMAT FORMAT FORMATO ФОРМАТ 尺寸	SPESSORE THICKNESS EPAISSEUR STÄRKE ESPEJOR ТОЛЩИНА 厚度	SCATOLA BOX BOÎTE KARTON CAJA КОРОБКА 盒子	EUROPALLET		
			m ²	box	m ²
270x120 . 106"x48"	6 mm . 0,24"	1	3,24	16	51,84
100x100 . 40"x40"	6 mm . 0,24"	2	2,00	26	52,00
120x120 . 48"x48"	8 mm . 0,31"	2	2,88	24	69,12
120x60 . 48"x24"	8 mm . 0,31"	2	1,44	36	51,84
60x60 . 24"x24"	8 mm . 0,31"	4	1,44	32	46,08
60x30 . 24"x12"	8 mm . 0,31"	8	1,44	40	57,60
100x100 . 40"x40" ANTISLIP	20 mm . 0,79"	1	1,00	24	24,00
120x60 . 48"x24" ANTISLIP	20 mm . 0,79"	1	0,72	32	23,04
120x30 . 48"x12" GRADINO L JOLLY	8 mm . 0,31"				
6,5x60 . 2,5"x24" BATTISCOPA	8 mm . 0,31"	10	0,39		

(WHITE BODY) Rivestimenti . Wall surfaces . Revêtements . Wandfliesen . Revestimientos . Плитка Для Стен . 牆面瓷磚













FORMATO SIZE FORMAT FORMAT FORMATO ФОРМАТ 尺寸	SPESSORE THICKNESS EPAISSEUR STÄRKE ESPEJOR ТОЛЩИНА 厚度	SCATOLA BOX BOÎTE KARTON CAJA КОРОБКА 盒子	EUROPALLET		
			m ²	box	m ²
120x40 . 48"x16"	8,5 mm . 0,33"	4	1,92	20	38,40
120x40 . 48"x16" LINE	10 mm . 0,39"	3	1,44	22	31,68
120x40 . 48"x16" DOMINO	10 mm . 0,39"	3	1,44	22	31,68
120x40 . 48"x16" TIDE	10 mm . 0,39"	3	1,44	22	31,68
120x40 . 48"x16" SHADE	10 mm . 0,39"	3	1,44	22	31,68

TECHNICAL CHARACTERISTICS

GRES PORCELLANATO

Grès porcellanato . Porcelain stoneware . Grès cérame . Feinsteinzeug . Gres porcelánico







CLASSIFICAZIONE SECONDO NORME EN14411 ALLEGATO G & ISO 13006 ALLEGATO G - GRUPPO BII UGL
 CLASSIFICATION IN ACCORDANCE WITH EN14411 ANNEX G & ISO 13006 ANNEX G - GRUPPO BII UGL / CLASSIFICATION SELON LES NORMES EN14411 ANNEXE G & ISO 13006 ANNEXE G - GROUPE BII UGL
 KLASSIFIZIERUNG GEMÄSS NORMEN EN14411 ANLAGE G & ISO 13006 ANLAGE G - GRUPPE BII UGL / CLASIFICACIÓN SEGÚN NORMAS EN14411 ADJUNTO G & ISO 13006 ADJUNTO G - GRUPO BII UGL

PROPRIETÀ FISICO-CHIMICHE PHYSICAL-CHEMICAL PROPERTIES PROPRIÉTÉS PHYSICO-CHIMIQUES PHYSIKALISCH-CHEMISCHE EIGENSCHAFTEN PROPIEDADES FÍSICO-QUÍMICAS	TIPO DI PROVA TYPE OF TEST NORME DU TEST TESTNORM TIPO DE PRUEBAS	VALORE PRESCRITTO REQUIRED VALUE VALEUR PRESCRITE VORGESCHRIEBENER WERT VALOR PRESCRITO	VALORE MEDIO AVERAGE VALUE VALEUR MOYENNE MITTELWERT VALOR MEDIO
		Lunghezza nominale del lato N - n ≥15 (cm) Nominal side length N - n ≥15 (cm) / Longueur nominale du côté N - n ≥15 (cm) Nennlänge der Seite N - n ≥15 (cm) / Longitud nominal del lado N - n ≥15 (cm)	
		Lunghezza e larghezza / Length and width / Longueur et largeur Länge und breite / Largura y anchura	± 0,6% / ± 2 mm
 Dimensioni Sizes Dimensions Abmessungen Dimensiones	ISO 10545.2	Spessore / Thickness / Epaisseur / Stärke / Espesor	± 5% / ± 0,5 mm
		Rettilineità spigoli / Warpage of edges / Rectitude des arêtes Kantengeradheit / Rectilineidad cantos	± 0,5% / ± 1,5 mm
		Ortogonalità / Wedging / Orthogonalité Rechtwinkligkeit / Ortogonalidad	± 0,5% / ± 2,0 mm
		Planarità / Warpage / Planéité / Ebenflächigkeit / Planitud	± 0,5% / ± 2,0 mm
 Qualità della superficie Surface quality Qualité de la surface Qualität der Oberfläche Calidad de la superficie	ISO 10545.2	Il 95% min delle piastrelle deve essere esente da difetti visibili At least 95% of the tiles must be free from visible flaws 95% des carreaux ne doivent pas avoir de défauts visibles Mindestens 95 % der Produkte müssen frei von sichtbaren Fehlern sein El 95% mín. de las tablas debe estar exento de defectos visibles	Conforme In conformity Conforme Erfüllt die Anforderungen Conforme
 Assorbimento d'acqua Water absorption Absorption d'eau Wasseraufnahme Absorción de agua	ISO 10545.3	≤ 0,5%	≤ 0,1%
 Resistenza alla flessione Bending strength Résistance à la flexion Biegefestigkeit Resistencia a la flexión	ISO 10545.4	Modulo di rottura / Moduls of rupture Module de rupture / Bruchmodul / Módulo de rotura	R ≥ 35 N/mm ² 49 N/mm ²
		Sforzo di rottura / Breaking stress Contrainte de rupture / Bruchlast / Esfuerzo de rotura	< 7,5mm = ≥ 700 N ≥ 7,5mm = ≥ 1300 N
 Resistenza all'abrasione profonda Deep resistance to abrasion Résistance à l'usure profonde Widerstand gegen tiefe Abrasion Resistencia al desgaste profundo	ISO 10545.6	Max 175 mm ³	140 mm ³
 Dilatazione termica lineare Coefficient of linear thermal expansion Coefficient de dilatation thermique lineaire Wärmeausdehnungskoeffizient Coeficiente de dilatación térmica lineal	ISO 10545.8	Metodo disponibile Test method available Méthode disponible Verfügbares Verfahren Método disponible	6,5x10 ⁻⁶ °C ⁻¹
 Resistenza agli sbalzi termici Resistance to thermal shock Résistance aux variations thermiques Temperaturwechselbeständigkeit Resistencia a los cambios de temperatura	ISO 10545.9	Metodo disponibile Test method available Méthode disponible Verfügbares Verfahren Método disponible	Resistente Résistant Widerstandsfähig Resistente
 Resistenza al gelo Frost resistance Résistance au gel Frostbeständigkeit Resistencia a las heladas	ISO 10545.12	Non devono presentare rotture o alterazioni apprezzabili della superficie Must not produce noticeable alteration to surface Ne doivent pas présenter des ruptures ou altérations trop importantes de la surface Oberflächen dürfen keinen bruch oder schaden aufweisen No deben presentar roturas o alteraciones apreciables de la superficie	Conforme In conformity Conforme Erfüllt die Anforderungen Conforme
 Resistenza ai prodotti chimici* Chemical resistance* Résistance aux produits chimiques* Chemikalienfestigkeit* Resistencia a los productos químicos*	ISO 10545.13	Resistenza ai prodotti chimici per uso domestico e additivi per piscina (min. CLASSE B) / Resistance to household chemicals and swimming pool additives (min. CLASSE B) / Résistance aux produits chimiques à usage domestique et aux additifs pour piscines (min. CLASSE B) / Beständigkeit gegen Haushaltschemikalien und Schwimmbadzusätze (mind. KLASSE B) / Resistencia a los productos químicos de uso doméstico y aditivos para piscinas (mín. CLASE B)	A Natural Natural Plus Structured Flamed / Antislip Glint / Jewel Silky / Polished Levigato Polished Top Lapped / Lapped
		Resistenza agli acidi ed alcalini a bassa concentrazione / Resistance to low concentration acids and alkalis / Résistance aux acides et alcalins à faible concentration / Beständigkeit gegen Säuren und Laugen niedriger Konzentration / Resistencia a los ácidos y alcalinos de baja concentración	LA Natural Natural Plus Structured Flamed / Antislip LB Glint / Jewel Silky / Polished Levigato Polished Top Lapped / Lapped
		Resistenza agli acidi ed alcalini ad alta concentrazione / Resistance to high concentration acids and alkalis / Résistance aux acides et alcalins à forte concentration / Beständigkeit gegen Säuren und Laugen hoher Konzentration / Resistencia a los ácidos y alcalinos de alta concentración	HA Natural Natural Plus Structured Flamed / Antislip HB Glint / Jewel Silky / Polished Levigato Polished Top Lapped / Lapped
 Resistenza alle macchie Stain resistance Resistance aux taches Fleckenbeständigkeit Resistencia a las manchas	ISO 10545.14	Metodo disponibile Test method available Méthode disponible Verfügbares Verfahren Método disponible	Classe 5 Natural Natural Plus Structured Available on request Glint / Jewel Silky / Polished Levigato Polished Top Lapped / Lapped
 Resistenza colori alla luce Resistance to light Résistance des couleurs à la lumière Lichtechtheit von Farben Resistencia de los colores a la luz	DIN 51094	Nessun campione deve presentare apprezzabili variazioni di colore No sample must show noticeable colour change Aucun échantillon ne doit présenter de variations de couleur visibles Keine Probe sollte nennenswerte Farbabweichungen aufweisen Ninguna muestra debe presentar variaciones apreciables de color	Campioni inalterati in brillantezza e colore No change in brightness or colour Brillance et couleur des échantillons inaltérées Unveränderte Muster in Helligkeit und Farbe Muestras inalteradas en brillo y color
 Resistenza allo scivolamento Slip resistance classification Résistance au glissement Rutschhemmung Resistencia al resbalamiento	ANSI A326.3 (BOT 3000) DIN EN 16165-B (ex DIN 51130)** DIN EN 16165-A (ex DIN 51097)**	ID - DCOF ≥ 0.42 (Dry) IW - DCOF ≥ 0.42 (Wet)	Disponibili a richiesta le classificazioni** Classifications available on request** Les classements sont disponibles sur demande** Auf Anfrage sind folgende Klassifizierungen erhältlich** Clasificaciones disponibles bajo pedido**
 Reazione al fuoco Reaction to fire Réaction au feu Brandverhalten Reacción al fuego	Decisione 96/603 CE Decision 96/603 CE	Prova assente	A1 - A1_n

WHITE BODY

Rivestimenti . Wall surfaces . Revêtements . Wandfliesen . Revestimientos

CLASSIFICAZIONE SECONDO NORME EN14411 ALLEGATO G & ISO 13006 ALLEGATO L - GRUPPO B III
 CLASSIFICATION IN ACCORDANCE WITH EN14411 ANNEX G & ISO 13006 ANNEX L - GRUPPO B III / CLASSIFICATION SELON LES NORMES EN14411 ANNEXE G & ISO 13006 ANNEXE L - GROUPE B III
 KLASSIFIZIERUNG GEMÄSS NORMEN EN14411 ANLAGE G & ISO 13006 ANLAGE L - GRUPPE B III / CLASIFICACIÓN SEGÚN NORMAS EN14411 ADJUNTO G & ISO 13006 ADJUNTO L - GRUPO B III

PROPRIETÀ FISICO-CHIMICHE PHYSICAL-CHEMICAL PROPERTIES PROPRIÉTÉS PHYSICO-CHIMIQUES PHYSIKALISCH-CHEMISCHE EIGENSCHAFTEN PROPIEDADES FÍSICO-QUÍMICAS	TIPO DI PROVA TYPE OF TEST NORME DU TEST TESTNORM TIPO DE PRUEBAS	VALORE PRESCRITTO REQUIRED VALUE VALEUR PRESCRITE VORGESCHRIEBENER WERT VALOR PRESCRITO	VALORE MEDIO AVERAGE VALUE VALEUR MOYENNE MITTELWERT VALOR MEDIO
		Lunghezza nominale del lato N - n ≥15 (cm) Nominal side length N - n ≥15 (cm) / Longueur nominale du côté N - n ≥15 (cm) Nennlänge der Seite N - n ≥15 (cm) / Longitud nominal del lado N - n ≥15 (cm)	
		Lunghezza e larghezza / Length and width / Longueur et largeur Länge und breite / Largura y anchura	± 0,5% ± 0,1%
 Dimensioni Sizes Dimensions Abmessungen Dimensiones	ISO 10545.2	Spessore / Thickness / Epaisseur / Stärke / Espesor	± 10% 8,5 ± 5% / 10,5 ± 5%
		Rettilineità spigoli / Warpage of edges / Rectitude des arêtes Kantengeradheit / Rectilineidad cantos	± 0,3% ± 0,1%
		Ortogonalità / Wedging / Orthogonalité Rechtwinkligkeit / Ortogonalidad	± 0,5% ± 0,1%
 Assorbimento d'acqua Water absorption Absorption d'eau Wasseraufnahme Absorción de agua	ISO 10545.3	> 10%	15-16%
 Resistenza alla flessione Bending strength Résistance à la flexion Biegefestigkeit Resistencia a la flexión	ISO 10545.4	Modulo di rottura / Moduls of rupture Module de rupture / Bruchmodul / Módulo de rotura	MIN. 12 N/mm ² Conforme / In conformity Conforme / Erfüllt die Anforderungen / Conforme
		Sforzo di rottura / Breaking stress Contrainte de rupture / Bruchlast / Esfuerzo de rotura	MIN. 600 N
 Resistenza agli sbalzi termici Resistance to thermal shock Résistance aux variations thermiques Temperaturwechselbeständigkeit Resistencia a los cambios de temperatura	ISO 10545.9	Metodo disponibile Test method available Méthode disponible Verfügbares Verfahren Método disponible	Resistente Résistant Widerstandsfähig Resistente
 Resistenza al cavillo Crazing resistance Résistance au tressaillage Haarrißbeständigkeit Resistencia al agrietado	ISO 10545.11	Richiesto Required Requis Erforderlich Exigido	Resistente Résistant Widerstandsfähig Resistente
 Resistenza ai prodotti chimici* Chemical resistance* Résistance aux produits chimiques* Chemikalienfestigkeit* Resistencia a los productos químicos*	ISO 10545.13	Resistenza ai prodotti chimici per uso domestico e additivi per piscina (min. CLASSE GB) / Resistance to household chemicals and swimming pool additives (min. CLASSE GB) / Résistance aux produits chimiques à usage domestique et aux additifs pour piscines (min. CLASSE GB) / Beständigkeit gegen Haushaltschemikalien und Schwimmbadzusätze (mind. KLASSE GB) / Resistencia a los productos químicos de uso doméstico y aditivos para piscinas (mín. CLASE GB)	GA
		Resistenza agli acidi ed alcalini a bassa concentrazione / Resistance to low concentration acids and alkalis / Résistance aux acides et alcalins à faible concentration / Beständigkeit gegen Säuren und Laugen niedriger Konzentration / Resistencia a los ácidos y alcalinos de baja concentración	GLA
		Resistenza agli acidi ed alcalini ad alta concentrazione / Resistance to high concentration acids and alkalis / Résistance aux acides et alcalins à forte concentration / Beständigkeit gegen Säuren und Laugen hoher Konzentration / Resistencia a los ácidos y alcalinos de alta concentración	GHA
 Resistenza alle macchie Stain resistance Resistance aux taches Fleckenbeständigkeit Resistencia a las manchas	ISO 10545.14	CLASSE 3 min.	Classe 5

* Ad eccezione dell'acido fluoridrico suoi derivati e composti - With the exception of hydrofluoric acid (hf) or its derivatives and compounds.

** I valori di resistenza allo scivolamento, coefficiente di attrito statico o dinamico, riportati sul sito catalogo e nella tabella Safe System sono da ritenersi puramente indicativi e non vincolanti. Ogni eventuale specifica necessità dovrà essere da noi confermata al momento dell'ordine e comunque sempre prima della posa. - Slip resistance values, coefficient of static or dynamic friction, in the website in the catalog and in the Safe System Table are purely indicative and not binding. Any specific requirements must be confirmed by us at the time of ordering and in any case before installation.

Creative Direction
Omniadvert

September 2025
LCG373

Iris Ceramica si riserva la facoltà di modificare in qualunque momento le informazioni e le caratteristiche illustrate in questo catalogo, che non sono comunque da ritenere legalmente vincolanti. I colori e le caratteristiche estetiche dei prodotti sono quanto più possibile vicini a quelli reali, nei limiti consentiti dai processi di stampa.

Iris Ceramica reserves the right to modify the information and the characteristics illustrated in this catalogue (which are in any case not legally binding) at any moment. The colours and appearance features of the products are as close as possible to reality, within the limitation of the printing process.

Iris Ceramica se réserve la faculté de modifier à tout moments les informations et les caractéristiques figurant dans le présent catalogue, lesquelles n'engagent pas par le fabricant au plan légal. Les couleurs et les caractéristiques esthétiques sont fidèles aux couleurs et caractéristiques réelles dans les limites des procédés d'impression.

Die Firma Iris Ceramica behält sich vor, die in diesem Katalog enthaltenen Informationen und Eigenschaften jederzeit zu ändern; sie gelten auf keinen Fall als gesetzlich bindend. Die Farben und ästhetischen Eigenschaften der Produkte kommen innerhalb der Möglichkeiten der Druckverfahren den tatsächlichen Eigenschaften so weit wie möglich nahe.

Iris Ceramica se reserva el derecho de modificar en cualquier momento la información y las características recogidas en este catálogo, que no deben considerarse jurídicamente vinculantes. Los colores y las características estéticas de los productos se asemejan a los reales en la medida en que lo permiten los límites impuestos por los procesos de impresión.

Компания Iris Ceramica сохраняет за собой право изменения информации и характеристик, указанных в данном каталоге, в любой момент без предварительного уведомления. Информация, характеристики и иллюстрации в каталоге не являются обязывающими. Цвета и эстетические характеристики продукции максимально приближены к реальным, насколько это позволяют сделать нынешние печатные технологии.

Iris Ceramica 保留随时修改本目录文字与图片信息的权利，并无需为此承担法律责任。在印刷工艺允许的范围内，产品颜色与外观特性尽可能与现实相符。

Iris Ceramica: tutti i diritti riservati. Ogni riproduzione totale o parziale dei contenuti di questo catalogo, sia di testo sia di immagine, è vietata e sarà perseguita a termini di legge.

Iris Ceramica: all rights reserved. Total or partial reproduction of text or illustrations of this catalogue is prohibited and is subject to legal sanctions.

Iris Ceramica: tous droits réservés. Toute reproduction totale ou partielle du contenu - textes et images - du présent catalogue est interdite et constituerait une contrefaçon sanctionnée par la loi.

Iris Ceramica: alle Rechte vorbehalten. Der vollständige oder auszugsweise Nachdruck des Inhalts dieses Katalog in Schrift und Bild ist verboten und wird nach Maßgabe des Gesetzes geahndet.

Iris Ceramica. Todos los derechos reservados. Queda prohibida la reproducción total o parcial de los contenidos de este catálogo, ya se trate del texto o de las imágenes. Cualquier infracción será sancionada por ley.

Iris Ceramica: все права защищены. Полное или частичное воспроизведение текста и иллюстраций, приведенных в каталоге, не допускается и преследуется по закону.

Iris Ceramica: 保留所有权利。抄袭或复制本目录全部或部分文字与图片属违法行为，如若违反将追究法律责任。

IRIS CERAMICA

Via Ghiarola Nuova, 119 - Zona industriale 1
41042 Fiorano Modenese (MO) - Italy
Telefono +39 0536 862.111
info@irisceramica.com
irisceramica.com

GranitiFiandre SpA
Via Radici Nord, 112 - 42014 Castellarano (RE) Italy

A BRAND OF  **IRIS
CERAMICA
GROUP**

