

# Pierre d'Avignon

STONE & CLASSIC  
COLLECTION



**Tagina**  
ITALY'S BEST SURFACES



# Pierre d'Avignon

## I N D E X



### **ISPIRAZIONE** 2

Inspiration.  
Inspiration.  
Inspiration.

### **CARATTERISTICHE DEL PROGETTO** 4

Project Features.  
Caractéristique du projet.  
Merkmale des Projekts.



### **DECORI** 6

Decors.  
Décors.  
Dekore.

### **COLLECTION OVERVIEW** 8

### **GALLERY** 11



### **TECHNICAL INFO** 39

### **MODULARITÀ** 44

Modularity.  
Modularité.  
Modularität.

### **TABELLE RIEPILOGATIVE** 46

Summary tables.  
Tableaux récapitulatifs.  
Zusammenfassende Tabellen.

### **ABBINARE COLORI E STILI** 52

Matching Colours and Styles.  
Faire correspondre les couleurs et les styles.  
Kombination von Farben und Stilen.

### **PEZZI SPECIALI** 54

Special pieces.  
Pièces spéciales.  
Formteile.

### **CARATTERISTICHE TECNICHE** 56

Technical features.



Caracteristiques techniques.  
Technische Eigenschaften.

## Suggerimenti provenzali

PIERRE D'AVIGNON è la nuova collezione di TAGINA che celebra la bellezza naturale della pietra di Avignone, tipica pietra locale che caratterizza i paesaggi e l'architettura della Provenza (Francia).

Grazie a un'innovativa tecnologia, questa serie riproduce con straordinaria fedeltà le caratteristiche estetiche e tattili della pietra, arricchita da raffinate finiture che esaltano la naturalezza e il realismo delle superfici.



### Provençal suggestions

PIERRE D'AVIGNON is the new TAGINA collection that celebrates the natural beauty of Avignon stone, a typical local stone that characterizes the landscapes and architecture of Provence (France). Thanks to innovative technology, this series offers an ultra-faithful reproduction of the aesthetic and tactile characteristics of the stone, enriched by refined finishes that enhance the natural and realistic appearance of the surfaces.



### Provenzalische Inspirationen

PIERRE D'AVIGNON ist die neue Kollektion von TAGINA, die die natürliche Schönheit des Avignon-Steins zelebriert, einem typischen lokalen Stein, der die Landschaften und die Architektur der Provence (Frankreich) prägt. Dank einer innovativen Technologie reproduziert diese Serie mit außergewöhnlicher Genauigkeit die ästhetischen und haptischen Eigenschaften des Steins, bereichert durch raffinierte Oberflächen, die die Natürlichkeit und den Realismus der Oberflächen unterstreichen.



### Suggestions provençales

PIERRE D'AVIGNON est la nouvelle collection de TAGINA, qui célèbre la beauté naturelle de la pierre d'Avignon, une pierre locale typique qui caractérise les paysages et l'architecture de la Provence (France). Grâce à une technologie novatrice, cette série reproduit avec une fidélité extraordinaire les caractéristiques esthétiques et tactiles de la pierre, enrichie de finitions raffinées qui exaltent le naturel et le réalisme des surfaces.



# Effetto pietra realistico

La superficie presenta studiate variazioni di riflesso che evocano il fascino dell'usura naturale della materia causata dal calpestio nel tempo. Questo dettaglio dona a pavimenti e rivestimenti un aspetto unico nonché decisamente autentico.

## Realistic stone effect

The surface comes with studied variations of reflection that evoke the charm of the natural wear of the material caused by being treaded on over time. This detail confers floors and walls a unique and markedly authentic appearance.

## Effet pierre réaliste

La surface se distingue par des variations étudiées de reflet, qui évoquent le charme de

l'usure naturelle du matériau causée par le piétinement au fil du temps. Ce détail confère aux sols et aux revêtements un aspect unique et résolument authentique.



## Realistischer Steineffekt

Die Oberfläche weist gezielt variierende Reflexionen auf, die den Charme der natürlichen Abnutzung des Materials durch die Beanspruchung im Laufe der Zeit hervorrufen. Dieses Detail verleiht Böden und Wänden ein einzigartiges und ausgesprochen authentisches Aussehen.



## Continuità di stile indoor, outdoor

Grazie alla duplice finitura Indoor e Outdoor R11, disponibile sia nel modulo a 4 formati che nei formati a bordo dritto, la collezione PIERRE D'AVIGNON offre soluzioni progettuali che garantiscono continuità tra ambienti interni ed esterni, mantenendo una coerenza stilistica che spazia dal rustico al contemporaneo.



## Indoor, outdoor style continuity

Thanks to the double Indoor and Outdoor R11 finish, available both in the 4-format module and in the straight-edge formats, the PIERRE D'AVIGNON collection offers design solutions that guarantee continuity between indoor and outdoor spaces, for a consistent style that ranges from rustic to contemporary.

## Continuité de style intérieur, extérieur

Grâce à la double finition Intérieur et Extérieur R11, disponible aussi bien dans le module à 4 formats que dans les formats à bord droit, la collection PIERRE D'AVIGNON offre des solutions de conception assurant une continuité entre les espaces intérieurs et extérieurs, en maintenant une cohérence stylistique qui embrasse le rustique et le contemporain.

## Stilkontinuität Indoor und Outdoor

Dank der doppelten Ausführung Indoor und Outdoor R11, die sowohl im 4-Formate-Modul als auch in den Formaten mit geradem Rand erhältlich ist, bietet die Kollektion PIERRE D'AVIGNON Designlösungen, die eine Kontinuität zwischen Innen- und Außenräumen gewährleisten und eine stilistische Kohärenz bewahren, die von rustikal bis modern reicht.

## Formati e pose modulari

La varietà di formati permette composizioni modulari fino a 4 elementi, 20x20, 20x40, 40x40 e 40x60, ideali in ogni ambiente.

Per accentuare l'effetto rustico e naturale, i bordi sono invecchiati e sagomati richiamando l'usura delle pietre data dal tempo.

I formati più contemporanei come il 60x60, 60x120 e 90x90, presentano bordi rettilinei e puliti, per un effetto minimale e raffinato.



## Modular formats and laying designs

The variety of formats allows modular compositions of up to 4 elements, 20x20, 20x40, 40x40 and 40x60, ideal in any environment. To accentuate the rustic and natural effect, the edges are aged and shaped, evoking the wear with passage of time. The most contemporary formats such as 60x60, 60x120 and 90x90, have straight and clear-cut edges, for a minimal and refined effect.

## Formats et poses modulaires

La variété de formats permet des compositions modulaires jusqu'à 4 éléments, 20 x 20, 20 x 40, 40 x 40 et 40 x 60, idéales dans tous les espaces. Les bords sont vieillis et façonnés afin d'exalter l'effet rustique et naturel, rappelant l'usure des pierres due au temps. Les formats plus modernes, comme le 60 x 60, 60 x 120 et 90 x 90, présentent des bords rectilignes et épurés, pour un effet minimaliste et raffiné.

## Modulare Formate und Verlegungen

Die Vielfalt der Formate ermöglicht modulare Kompositionen mit bis zu 4 Elementen, 20x20, 20x40, 40x40 und 40x60, ideal für jede Umgebung. Um den rustikalen und natürlichen Effekt zu betonen, sind die Randbereiche gealtert und geformt, was an die Abnutzung der Steine durch die Zeit erinnert. Die zeitgemäßen Formate wie 60x60, 60x120 und 90x90 haben gerade und klare Ränder für einen minimalistischen und raffinierten Effekt.

## Affascinanti decorazioni

La varietà di decori disponibili, rende la collezione PIERRE D'AVIGNON ideale per chi cerca un equilibrio tra tradizione e comfort moderno.

Il formato 60x120 cm del decoro PROVENCE, con il suo design acquerellato, interpreta atmosfere naturali aggiungendo calore e intimità agli ambienti.

Nel formato 20x20 cm, il decoro ARLES offre un'eleganza classica dalle suggestioni antiche, evocando la bellezza autentica della pietra.

### Charming decorations

The variety of decorations available makes of PIERRE D'AVIGNON an ideal collection for those seeking a balance between tradition and modern comfort. With its watercolor design, the 60x120 cm format of the PROVENCE decoration defines natural atmospheres adding warmth and intimacy to the rooms.

In the 20x20 cm format, the ARLES decoration offers a classic elegance with ancient suggestions, evoking the authentic beauty of the stone.

### Des décorations fascinantes

La variété de décors disponibles rend la collection PIERRE D'AVIGNON parfaite pour ceux qui recherchent un équilibre entre tradition et confort moderne. Avec son design style aquarelle, le format 60 x 120 cm du décor PROVENCE interprète des atmosphères naturelles en apportant de la chaleur et de l'intimité aux espaces.

Au format 20 x 20 cm, le décor ARLES offre une élégance classique aux suggestions anciennes, évoquant la beauté authentique de la pierre.

### Faszinierende Dekorationen

Die Vielfalt der verfügbaren Dekore macht die Kollektion PIERRE D'AVIGNON ideal für diejenigen, die ein Gleichgewicht zwischen Tradition und modernem Komfort suchen. Das Format 60x120 cm des Dekors PROVENCE interpretiert mit seinem Aquarelldesign natürliche Atmosphären und verleiht den Räumen Wärme und Intimität. Im Format 20x20 cm bietet das Dekor ARLES eine klassische Eleganz mit antiken Anklängen und erinnert an die authentische Schönheit des Steins.

## PROVENCE 60x120

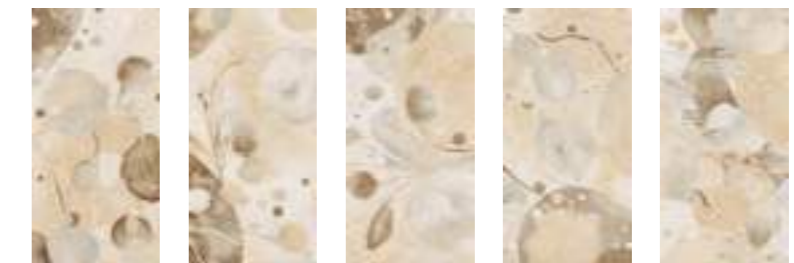

## ARLES 20x20



COLLECTION OVERVIEW

PIERRE D'AVIGNON è la scelta ideale per chi cerca una ceramica che unisce la bellezza della natura alla praticità del gres porcellanato, offrendo soluzioni estetiche moderne e di grande impatto,





senza rinunciare all'autenticità delle finiture. Un viaggio sensoriale che porta il fascino delle pietre di Avignone nelle case di oggi.

PIERRE D'AVIGNON

PIERRE D'AVIGNON is the ideal choice for those in search of a ceramic that blends the beauty of nature with the practicality of porcelain stoneware, for modern and high-impact aesthetic solutions, while maintaining the authenticity of the finishes. A sensory journey that adds the touch of charm of Avignon stones to modern day homes.

PIERRE D'AVIGNON est le choix idéal pour ceux qui recherchent une céramique alliant la beauté de la nature à la praticité du grès cérame, offrant des solutions esthétiques actuelles et à fort impact, sans renoncer à l'authenticité des finitions. Un voyage sensoriel qui porte le charme de la pierre d'Avignon dans les maisons d'aujourd'hui.

PIERRE D'AVIGNON ist die ideale Wahl für diejenigen, die eine Keramik suchen, die die Schönheit der Natur mit der Zweckmäßigkeit von Feinsteinzeug verbindet und moderne und wirkungsvolle ästhetische Lösungen bietet, ohne auf die Authentizität der Oberflächen zu verzichten. Eine Sinnesreise, die den Charme der Avignon-Steine in die Häuser von heute bringt.

		INDOOR							OUTDOOR					DECORI		
		SHADE SPECTRUM V3 R10 INDOOR							SHADE SPECTRUM V3 R11 A+B+C OUTDOOR					SHADE SPECTRUM V3 R10 INDOOR		
		Mosaico (5x5)														
FORMATO · SIZE · FORMAT · FORMAT		90x90 35½"x35½"	60x120 24"x48"	60x60 24"x24"	40x60 16"x24"	40x40 16"x16"	20x40 8"x16"	20x20 8"x8"	30x30 12"x12"	40x60 16"x24"	40x40 16"x16"	20x40 8"x16"	20x20 8"x8"	90x90 35½"x35½"	60x120 24"x48"	20x20 8"x8"
SPESSORE · THICKNESS · ÉPAISSEUR · STÄRKE		9 mm	9 mm	9 mm	9 mm	9 mm	9 mm	9 mm	9 mm	9 mm R11	9 mm R11	9 mm R11	9 mm R11	20 mm R11	9 mm	9 mm
N° DI GRAFICHE · No OF GRAPHICS · N° DE GRAPHISMES · N° DER GRAFIKEN		16	16	32	44	44	44	88		44	44	44	88	16	6	18
 <b>BLANC</b> □ Nat. Ret.		●	●	●	●	●	●	●	●	●	●	●	●	●	●	●
 <b>BEIGE</b> □ Nat. Ret.		●	●	●	●	●	●	●	●	●	●	●	●	●	●	●
 <b>GRIS</b> □ Nat. Ret.		●	●	●	●	●	●	●	●	●	●	●	●	●	●	●
 <b>PORPHYRE</b> □ Nat. Ret.		●	●	●	●	●	●	●	●	●	●	●	●	●	●	●
	<b>ABBINAMENTI · MATCHING COMBINAISONS · KOMBINATIONEN</b>														●	

---

GALLERY

Pierre d'Avignon

 **Tagina**  
ITALY'S BEST SURFACES

PIERRE D'AVIGNON

# Beige



Modulo D1: BEIGE 40x60 . 40x40 . 20x40 . 20x20 Nat. Ret.

RIVESTIMENTO . WALL  
Decoro Provence 60x120 Nat. Ret.  
BEIGE Coprispigo triangolare 1,40x120 Nat. Ret.  
BEIGE Mosaico 30x30 Nat. Ret.  
PORPHYRE Mosaico 30x30 Nat. Ret.

PAVIMENTO. FLOOR  
BEIGE 60x60 Nat. Ret.  
BEIGE Mosaico 30x30 Nat. Ret.





BEIGE 90x90 20 mm Nat. Ret. R11  
Special pieces for swimming pool  
BEIGE Gradone grip bordo piscina + Ang. 30x90 20 mm Nat. Ret. R11  
BEIGE Griglia + Ang. 20x60 20 mm Nat. Ret. R11

---

RIVESTIMENTO . WALL  
Collection MARMÌ IMPERIALI, ZENOBIA 90x90 Nat. Ret.

GRADINO . STEP TREAD  
BLANC 60x120 Nat. Ret.  
BLANC Coprispigolo triangolare 1,4x120 Nat. Ret.

PAVIMENTO . FLOOR  
BEIGE 60x120 Nat. Ret.  
BLANC 60x120 Nat. Ret.



PIERRE D'WIGNON

# Blanc

RIVESTIMENTO . WALL  
Collection MARMİ IMPERIALI, ZENOBIA 90x90 Nat. Ret.

SCALE . STAIRS  
BLANC 60x120 Nat. Ret.  
BLANC Coprispigolo triangolare 1,4x120 Nat. Ret.

PAVIMENTO . FLOOR  
BLANC 60x120 Nat. Ret.





BLANC 90x90 Nat. Ret.



SCALE . STAIRS  
BLANC 60x120 Nat. Ret.  
BLANC Coprispigo triangolare 1,4x120 Nat. Ret.

PAVIMENTO . FLOOR  
BLANC 60x120 Nat. Ret.

INDOOR  
RIVESTIMENTO . WALL  
BLANC 60x120 Nat. Ret.

PAVIMENTO . FLOOR  
BLANC 90x90 Nat. Ret.

OUTDOOR  
BLANC 90x90 20 mm Nat. Ret. R11



PIERRE D'AVIGNON

# Porphyre

RIVESTIMENTO . WALL  
BEIGE 20x20 Nat. Ret.  
BEIGE Decoro Arles 20x20 Nat. Ret.

PAVIMENTO . FLOOR  
Modulo C1  
PORPHYRE 40x40 . 20x40 . 20x20 Nat. Ret.



PIERRE D'AVIGNON

---

Modulo C1 Indoor Outdoor  
PORPHYRE 40x40 . 40x20 . 20x20 Nat. Ret. R11  
Elemento a L monolitico 15x30x4h Nat. Ret. R11



PORPHYRE 20x20 Nat. Ret. - Decoro Arles 20x20 Nat. Ret.



PORPHYRE 90x90 Nat. Ret.



PIERRE D'AVIGNON

# Gris

RIVESTIMENTO . WALL  
Collection CITY STONE, Listello SALVIA 5x15 Nat.

FRONTE BANCONE . COUNTERFRONT  
Collection CITY STONE, Listello SALVIA 5x15 Nat.

PAVIMENTO . FLOOR  
Modulo D2  
GRIS 40x60 . 40x40 . 20x40 . 20x20 Nat. Ret.

Modulo D2  
GRIS 40x60 . 40x40 . 20x40 . 20x20 Nat. Ret.



GRIS 90x90 20 mm Nat. Ret. R11  
GRIS Elemento a L 33x90x4



---

## TECHNICAL INFO

# Pierre d'Avignon



# BLANC



# GRIS



## BEIGE



## PORPHYRE



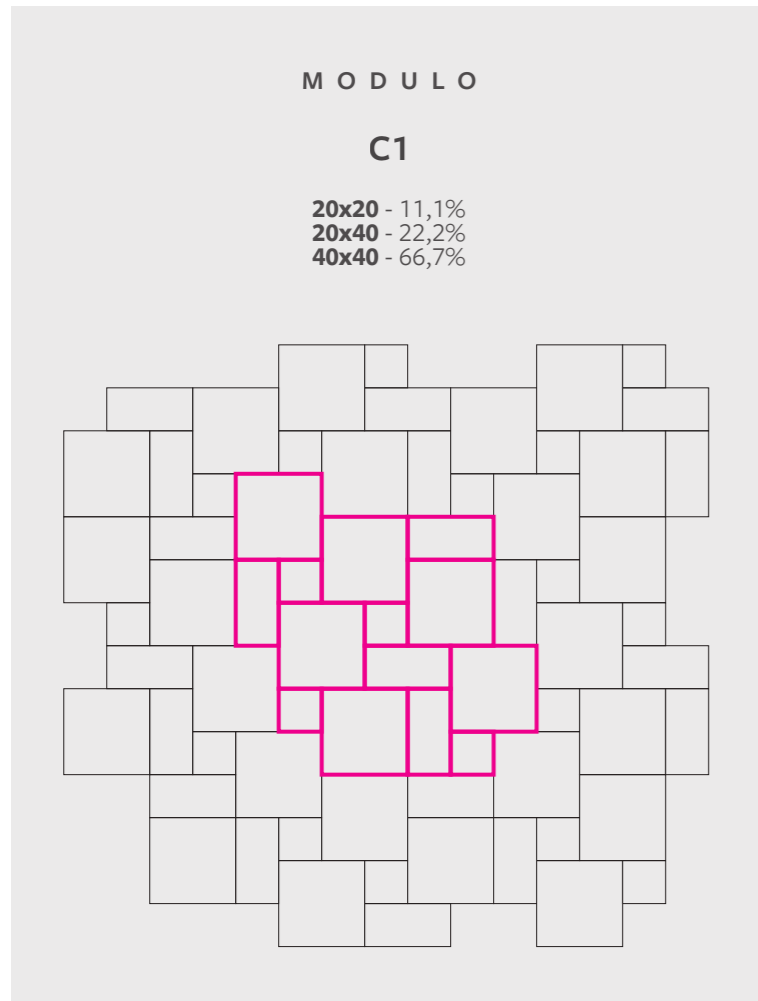

Porphyre

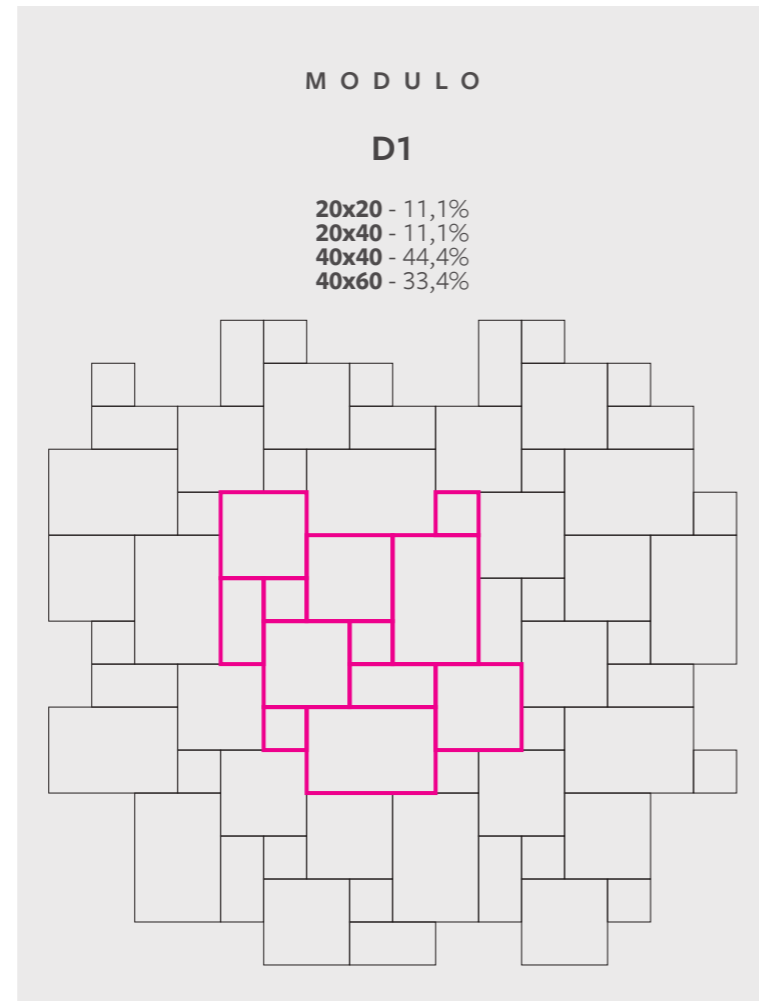

Beige

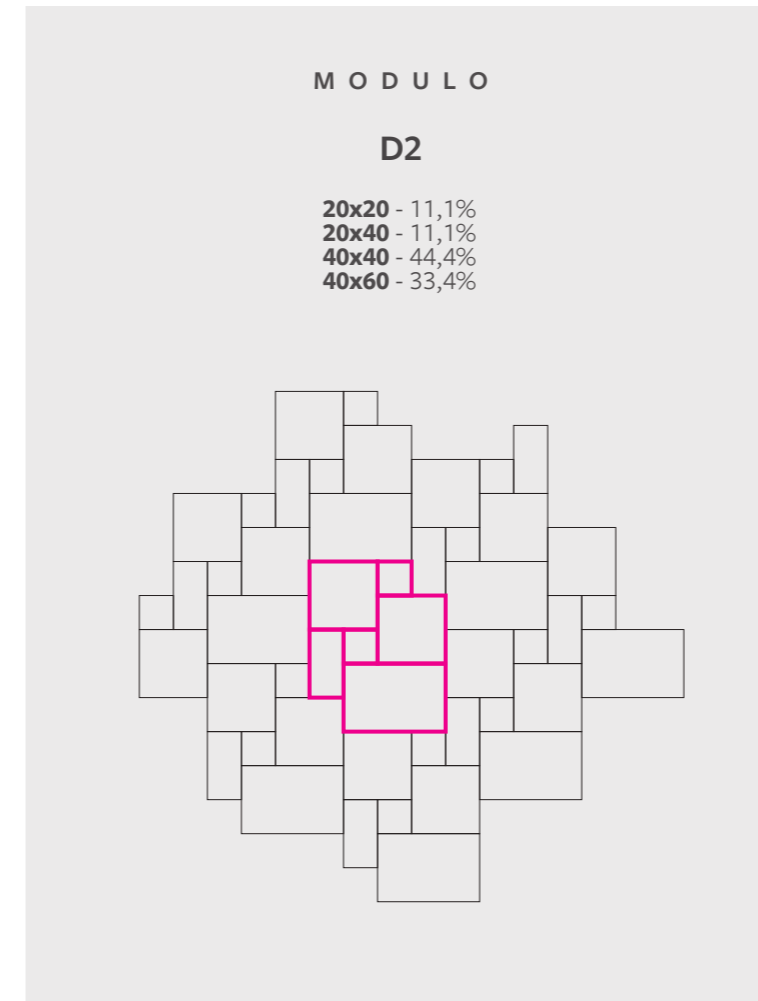

Gris

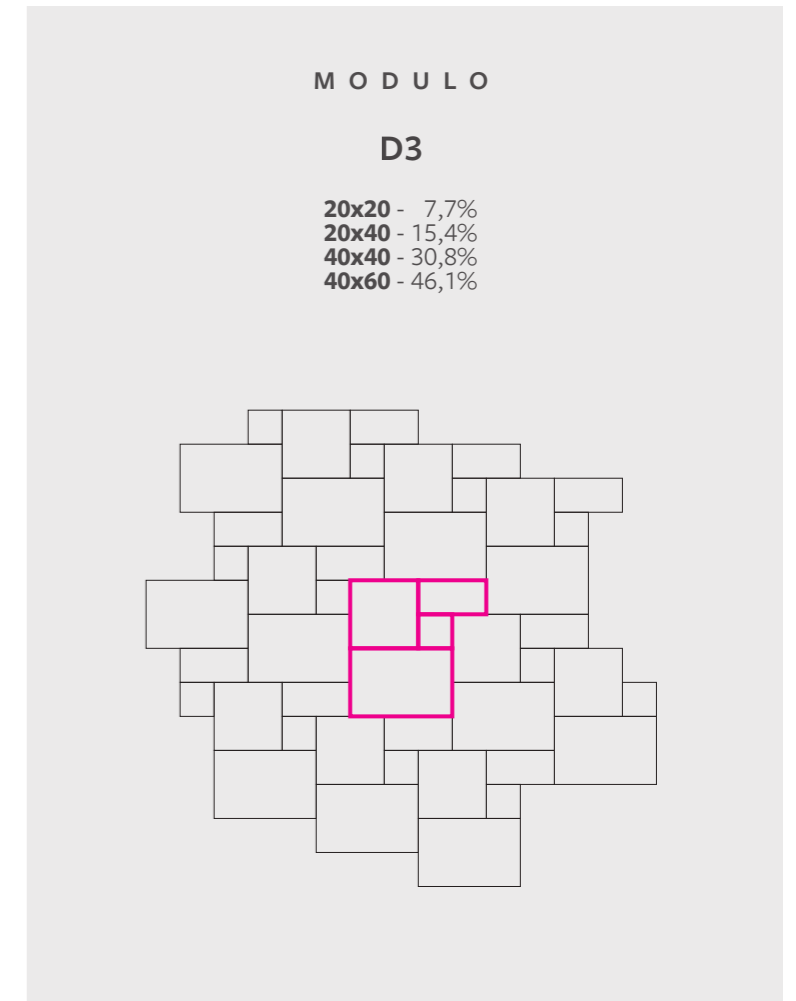

Blanc



Per approfondire il tema degli schemi di posa scarica il catalogo.  
To learn more about laying diagrams, download our catalogue.  
Pour approfondir le thème des schémas de pose, téléchargez le catalogue.  
Laden Sie den Katalog herunter, um mehr über die Verlegemuster zu erfahren.

**Spessore . Thickness . Epaisseur . Stärke - 9 mm**

**Gres porcellanato colorato in massa.** Full-body coloured porcelain stoneware. Grès cérame coloré dans la masse. In der Masse gefärbtes Feinsteinzeug.

## INDOOR

TABELLA RIEPILOGATIVA  
Summary table  
Tableau récapitulatif  
Zusammenfassende Tabelle

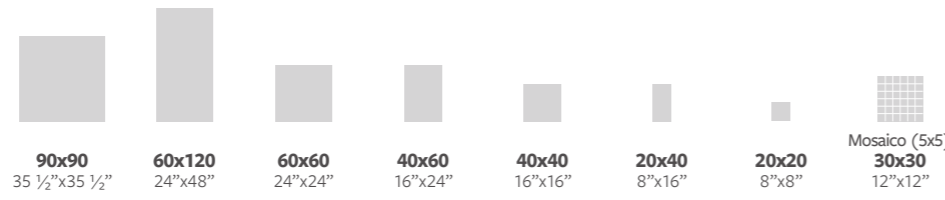

## DECORI

Decors  
Décors  
Dekore

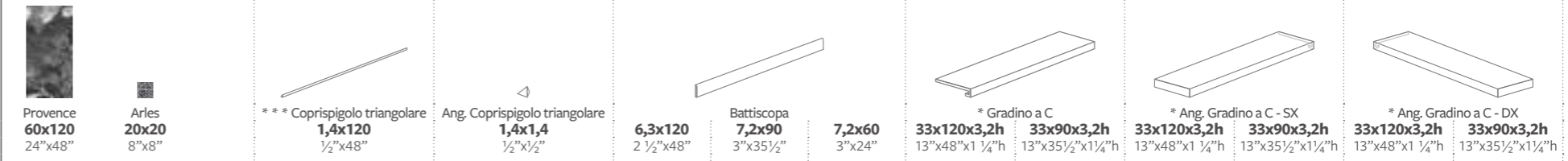

SPESSORE - THICKNESS - EPAISSEUR - STÄRKE		▼ 9 mm	▼ 9 mm	▼ 9 mm	▼ 9 mm	▼ 9 mm	▼ 9 mm	▼ 9 mm	▼ 9 mm	▼ 9 mm	▼ 9 mm	▼ 9 mm	▼ 9 mm	▼ 9 mm	▼ 9 mm	▼ 9 mm	▼ 9 mm	▼ 9 mm	▼ 9 mm	▼ 9 mm	▼ 9 mm	
	<b>BLANC</b> □ Nat. Ret.	147001	147011	147017	147021	147031	147041	147051	147301	147060	147068	147401	147411	147111	147121	147131	147201	147205	147209	147213	147217	147221
	<b>BEIGE</b> □ Nat. Ret.	147002	147012	147018	147022	147032	147042	147052	147302		147069	147402	147412	147112	147122	147132	147202	147206	147210	147214	147218	147222
	<b>GRIS</b> □ Nat. Ret.	147003	147013	147019	147023	147033	147043	147053	147303		147070	147403	147413	147113	147123	147133	147203	147207	147211	147215	147219	147223
	<b>PORPHYRE</b> □ Nat. Ret.	147004	147014	147020	147024	147034	147044	147054	147304		147071	147404	147414	147114	147124	147134	147204	147208	147212	147216	147220	147224

IMBALLI - PACKAGING EMBALLAGE - VERPACKUNG																					
	Pallet	Pallet	Pallet	Pallet	Pallet	Pallet	Pallet	Pallet	Pallet	Pallet	Pallet	Pallet	Pallet	Pallet	Pallet	Pallet	Pallet	Pallet	Pallet	Pallet	Pallet
	94x120	80x120	80x120	80x120	80x120	80x120	80x120	80x120	80x120	80x120	80x120	80x120	80x120	80x120	80x120	80x120	80x120	80x120	80x120	80x120	80x120
N°																					
m²																					
Kg																					
x	2	2	3	4	6	8	16	11	2	16	6	9	8	14	2	2	1	1	1	1	1
m² x	1,62	1,44	1,08	0,96	0,96	0,64	0,64	0,99	1,44	0,64	1,8	14,2	10	8,5	21	15	10,5	7,5	10,5	7,5	
Kg x	33	29	22	19,5	19,5	12,8	12,8	19,5	29	12,8	1,8	14,2	10	8,5	21	15	10,5	7,5	10,5	7,5	
x	20	32	40	48	60	72	72	32	32	72											
m² x	32,4	46,08	43,2	46,08	57,6	46,08	46,08	46,08	46,08	46,08											
** Kg x	682	948	900	956	1190	941,6	941,6	941,6	941,6	941,6											
h x	64	75	75	73	94	73	73	73	75	73											
Imballo (tara) - Packaging (tare)	(20)	(20)	(20)	(20)	(20)	(20)	(20)	(20)	(20)	(20)	(20)	(20)	(20)	(20)	(20)	(20)	(20)	(20)	(20)	(20)	(20)

	MODULO C1 40x40- 20x40 - 20x20	MODULO D1 - D2 - D3 40x60 - 40x40- 20x40 - 20x20
SPESSORE - THICKNESS - EPAISSEUR - STÄRKE	▼ 9 mm	▼ 9 mm

▼ Gli articoli nel nuovo spessore 9 mm saranno disponibili ad esaurimento dello stock esistente in spessore 10 mm.  
9 mm items will be available once the current 10 mm stock we have has run out.  
Les articles de 9 mm d'épaisseur seront disponibles dès que le stock en 10 mm sera terminé.  
Die 9 mm Artikel werden verfügbar sein, sobald die 10 mm Lagerbestände abverkauft sind.

I pesi riportati in tabella sono indicativi e potrebbero essere soggetti a leggere variazioni.  
The weights stated in the chart may undergo slight changes for production reasons.  
Les poids indiqués dans le tableau peuvent subir de légères variations pour des raisons de production.  
Die in der Tabelle angegebenen Gewichte können aus Produktionsgründen geringfügigen Abweichungen unterliegen.

\* A disposizione solo su richiesta. Tempi di consegna 30 gg.  
Available upon request only. Delivery terms: 30 days.  
Disponible seulement sur requête. Délais de livraison: 30 jours.  
Verfügbar auf Anfrage. Lieferzeit: 30 Tage.

\*\* Il peso è comprensivo dell'imballo.  
The total weight includes the packaging.  
Le poids comprend aussi l'emballage.  
Das Gesamtgewicht enthält auch die Verpackung.

\*\*\* Vendita a scatola completa.  
Full box sale.  
Vente à la boîte complète.  
Volle Kartons.

Non si garantisce l'abbinabilità tra fondi di spessori diversi e tra fondo e pezzo speciale.  
It is not guaranteed that background tiles with different thicknesses can be used together, nor is it guaranteed for background tiles and trims.  
Nous ne garantissons pas la possibilité de combiner des carrelages de sol de différentes épaisseurs et un carrelage de sol avec une pièce spéciale.  
Die Kombinierbarkeit von Fliesen unterschiedlicher Stärke sowie zwischen Fliese und Formteil kann nicht garantiert werden.

□ Naturale e rettificato.  
Natural rectified.  
Naturel et rectifié.  
Natur Oberfläche und rektifiziert.

I decori si abbinano al fondo ma possono essere di tonalità diversa.  
Decors match the base but may be of a different tone.  
Les décors sont assortis au fond, mais les tonalités peuvent être différentes.  
Die Dekore passen zum Unifliese, können jedoch unterschiedliche Farbtöne aufweisen

**Spessore . Thickness . Epaisseur . Stärke: 9 mm R11 - 20 mm R11**

**Gres porcellanato colorato in massa.** Full-body coloured porcelain stoneware. Grès cérame coloré dans la masse. In der Masse gefärbtes Feinsteinzeug.

## OUTDOOR

TABELLA RIEPILOGATIVA  
Summary table  
Tableau récapitulatif  
Zusammenfassenden Tabelle

		40x60 16"x24"	40x40 16"x16"	20x40 8"x16"	20x20 8"x8"	90x90 35 1/2"x35 1/2"	* Elemento a L monolitico △ 15x30x4h 6"x12"x1 1/2"h
SPESSORE - THICKNESS - EPAISSEUR - STÄRKE		▼ 9 mm	▼ 9 mm	▼ 9 mm	▼ 9 mm	20 mm	9,5 mm
	□ Nat. Ret.	147080	147086	147092	147098	147501	
	■ Nat. Nat.						147151
	□ Nat. Ret.	147081	147087	147093	147099	147502	
	■ Nat. Nat.						147152
	□ Nat. Ret.	147082	147088	147094	147100	147503	
	■ Nat. Nat.						147153
	□ Nat. Ret.	147083	147089	147095	147101	147504	
	■ Nat. Nat.						147154
<b>IMBALLI - PACKAGING</b> EMBALLAGE - VERPACKUNG							
		Pallet	Pallet	Pallet	Pallet	Pallet	Pallet
		80x120	80x120	80x120	80x120	94x94	80x120
N° □							
m²							
Kg							
		4	6	8	16	1	6
m² x		0,96	0,96	0,64	0,64	0,81	
Kg x		19,5	19,5	12,8	12,8	37	7,5
		48	60	72	72	30	
m² x		46,08	57,6	46,08	46,08	24,3	
** Kg x		956	1190	941,6	941,6	1130	
h x		73	94	73	73	80	
Imballo (tara) - Packaging (tare)		(20)	(20)	(20)	(20)	(20)	(20)

	MODULO <b>C1</b> 40x40- 20x40 - 20x20	MODULO <b>D1 - D2 - D3</b> 40x60 - 40x40- 20x40 - 20x20
SPESSORE - THICKNESS - EPAISSEUR - STÄRKE	▼ 9 mm	▼ 9 mm

▼ Gli articoli nel nuovo spessore 9 mm saranno disponibili ad esaurimento dello stock esistente in spessore 10 mm.  
9 mm items will be available once the current 10 mm stock we have has run out.  
Les articles de 9 mm d'épaisseur seront disponibles dès que le stock en 10 mm sera terminé.  
Die 9 mm Artikel werden verfügbar sein, sobald die 10 mm Lagerbestände abverkauft sind.

I pesi riportati in tabella sono indicativi e potrebbero essere soggetti a leggere variazioni.  
The weights stated in the chart may undergo slight changes for production reasons.  
Les poids indiqués dans le tableau peuvent subir de légères variations pour des raisons de production.  
Die in der Tabelle angegebenen Gewichte können aus Produktionsgründen geringfügigen Abweichungen unterliegen.

Non si garantisce l'abbinabilità tra fondi di spessori diversi e tra fondo e pezzo speciale.  
It is not guaranteed that background tiles with different thicknesses can be used together, nor is it guaranteed for background tiles and trims.  
Nous ne garantissons pas la possibilité de combiner des carrelages de sol de différentes épaisseurs et un carrelage de sol avec une pièce spéciale.  
Die Kombinierbarkeit von Fliesen unterschiedlicher Stärke sowie zwischen Fliese und Formteil kann nicht garantiert werden.

\* A disposizione solo su richiesta. Tempi di consegna 30 gg.  
Available upon request only. Delivery terms: 30 days.  
Disponible seulement sur requête. Délais de livraison: 30 jours.  
Verfügbar auf Anfrage. Lieferzeit: 30 Tage.

\*\* Il peso è comprensivo dell'imballo.  
The total weight includes the packaging.  
Le poids comprend aussi l'emballage.  
Das Gesamtgewicht enthält auch die Verpackung.

## PEZZI SPECIALI PER ESTERNO

Special pieces for outdoor  
Pièces spéciales pour extérieur  
Formteile für Aussenbereich

**20 mm R11 - □ Nat. Ret.**

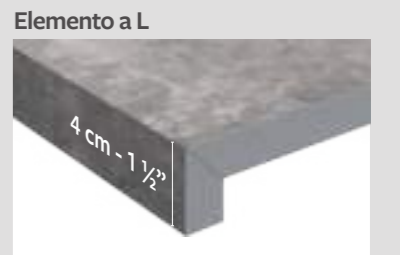
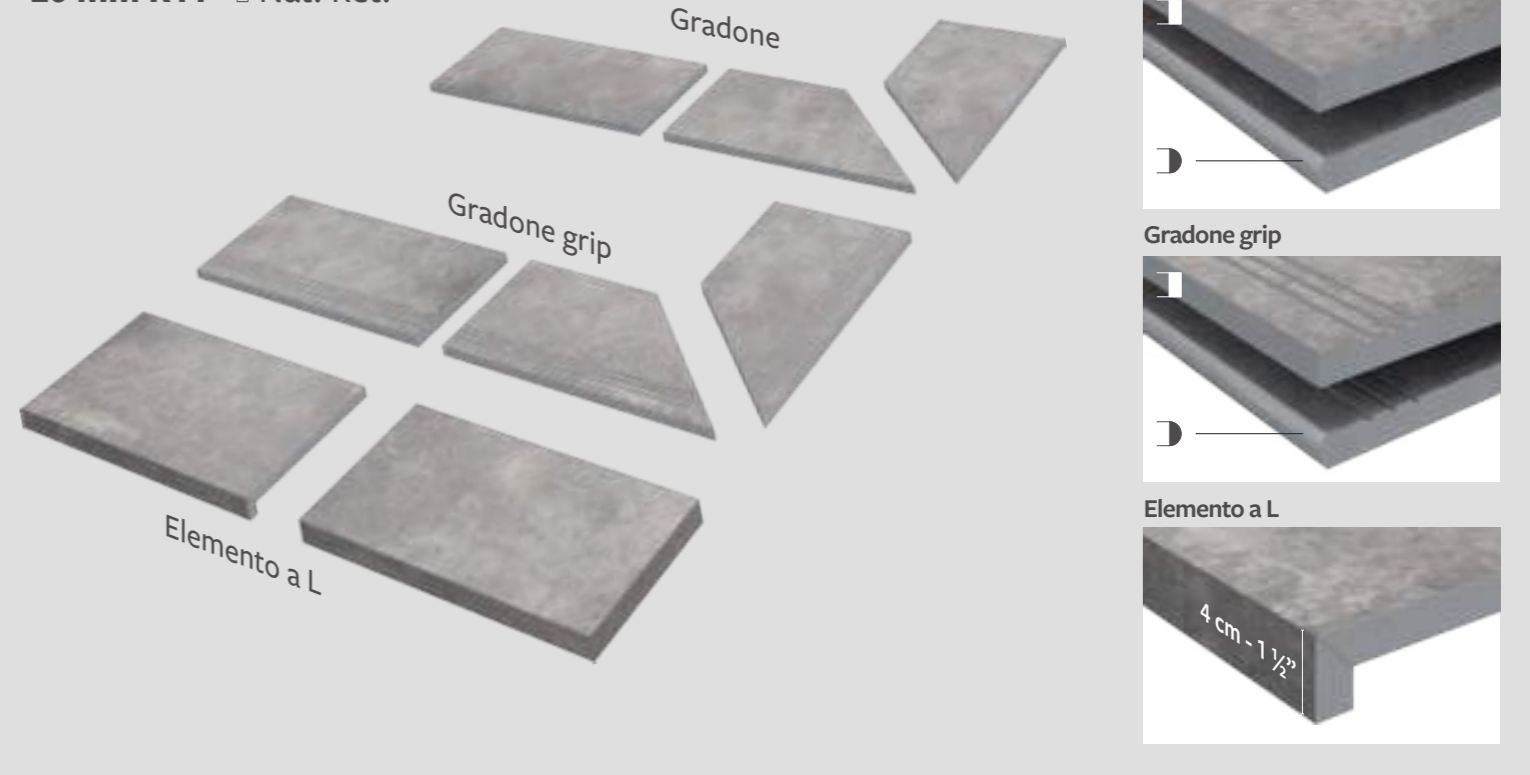

## PEZZI SPECIALI PER PISCINA

Special pieces for swimming pool  
Pièces spéciales pour piscine  
Formteile für Schwimmbad

**20 mm R11 - □ Nat. Ret.**

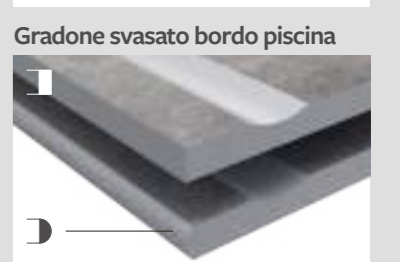
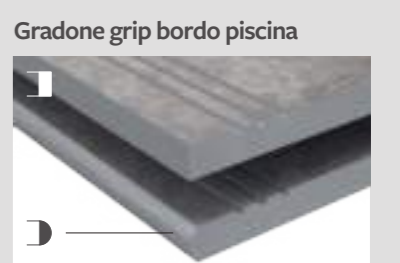
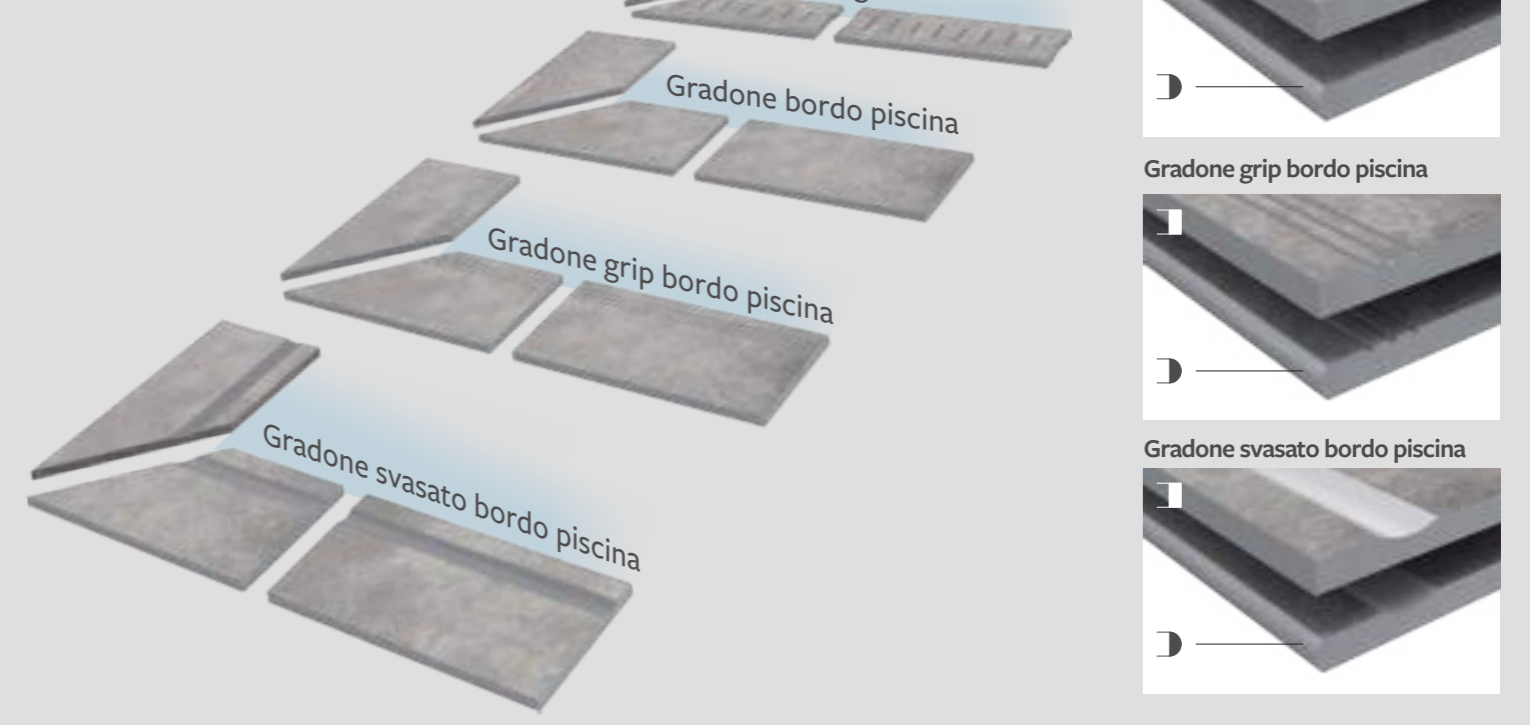









□ Naturale e rettificato. Natural rectified. Naturél et rectifié. Natur Oberfläche und rektifiziert.  
■ Naturale e naturale. Natural and natural. Naturél et naturel. Natur natur.  
△ Monolitico. Monolithic step. Monolitico. Monolithische Stufenplatte.

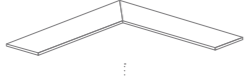





▬ Costa retta. Straight edge. Bord droit. Gerade Kante.  
● Costa toro. Bullnose edge. Bord boudin. Abgerundete Kante.

# PIERRE D'AVIGNON

## PEZZI SPECIALI PER ESTERNO 20 mm R11 - □ Nat. Ret.

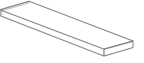
Special pieces for outdoor - Pièces spéciales pour extérieur - Formteile für Aussenbereich

							
		* Gradone	* Ang. Gradone - SX	* Ang. Gradone - DX	* Gradone grip	* Ang. Gradone grip - SX	* Ang. Gradone grip - DX
		30x90 12"x35 1/2"	30x90 12"x35 1/2"	30x90 12"x35 1/2"	30x90 12"x35 1/2"	30x90 12"x35 1/2"	30x90 12"x35 1/2"
<b>BLANC R11</b>	┌	147601	147609	147617	147625	147633	147641
	┐	147605	147613	147621	147629	147637	147645
<b>BEIGE R11</b>	┌	147602	147610	147618	147626	147634	147642
	┐	147606	147614	147622	147630	147638	147646
<b>GRIS R11</b>	┌	147603	147611	147619	147627	147635	147643
	┐	147607	147615	147623	147631	147639	147647
<b>PORPHYRE R11</b>	┌	147604	147612	147620	147628	147636	147644
	┐	147608	147616	147624	147632	147640	147648
		1	1	1	1	1	1
		13,5	10,5	10,5	13,5	10,5	10,5
							







				
		* Elemento a L	* Elemento a L - SX	* Elemento a L - DX
		33x90x4h 13"x35 1/2"x1 1/2" h	33x90x4h 13"x35 1/2"x1 1/2" h	33x90x4h 13"x35 1/2"x1 1/2" h
<b>BLANC R11</b>		147649	147653	147657
<b>BEIGE R11</b>		147650	147654	147658
<b>GRIS R11</b>		147651	147655	147659
<b>PORPHYRE R11</b>		147652	147656	147660
		2	1	1
		28,2	14,1	14,1
				



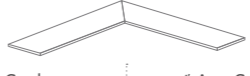

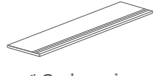
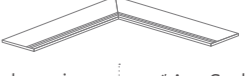

I pesi riportati in tabella sono indicativi e potrebbero essere soggetti a leggere variazioni.  
The weights stated in the chart may undergo slight changes for production reasons.  
Les poids indiqués dans le tableau peuvent subir de légères variations pour des raisons de production.  
Die in der Tabelle angegebenen Gewichte können aus Produktionsgründen geringfügigen Abweichungen unterliegen.

Non si garantisce l'abbinabilità tra fondi di spessori diversi e tra fondo e pezzo speciale.  
It is not guaranteed that background tiles with different thicknesses can be used together, nor is it guaranteed for background tiles and trims.  
Nous ne garantissons pas la possibilité de combiner des carrelages de sol de différentes épaisseurs et un carrelage de sol avec une pièce spéciale.  
Die Kombinierbarkeit von Fliesen unterschiedlicher Stärke sowie zwischen Fliese und Formteil kann nicht garantiert werden.

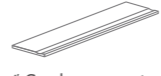
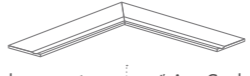
## PEZZI SPECIALI PER PISCINA 20 mm R11 - □ Nat. Ret.

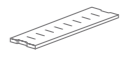
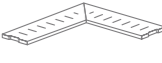
Special pieces for swimming pool - Pièces spéciales pour piscine - Formteile für Schwimmbad

							
		* Gradone bordo piscina	* Ang. Gradone bordo piscina - SX	* Ang. Gradone bordo piscina - DX	* Gradone grip bordo piscina	* Ang. Gradone grip bordo piscina - SX	* Ang. Gradone grip bordo piscina - DX
		30x90 12"x35 1/2"	30x90 12"x35 1/2"	30x90 12"x35 1/2"	30x90 12"x35 1/2"	30x90 12"x35 1/2"	30x90 12"x35 1/2"
<b>BLANC R11</b>	┌	147601	147661	147669	147625	147677	147685
	┐	147605	147665	147673	147629	147681	147689
<b>BEIGE R11</b>	┌	147602	147662	147670	147626	147678	147686
	┐	147606	147666	147674	147630	147682	147690
<b>GRIS R11</b>	┌	147603	147663	147671	147627	147679	147687
	┐	147607	147667	147675	147631	147683	147691
<b>PORPHYRE R11</b>	┌	147604	147664	147672	147628	147680	147688
	┐	147608	147668	147676	147632	147684	147692
		1	1	1	1	1	1
		13,5	10,5	10,5	13,5	10,5	10,5
							

							
		* Gradone svasato bordo piscina	* Ang. Gradone svasato bordo piscina - SX	* Ang. Gradone svasato bordo piscina - DX	* Griglia	* Griglia - SX	* Griglia - DX
		30x90 12"x35 1/2"	30x90 12"x35 1/2"	30x90 12"x35 1/2"	20x60 8"x24"	20x60 8"x24"	20x60 8"x24"
<b>BLANC R11</b>	┌	147693	147701	147709	147717	147721	147725
	┐	147697	147705	147713			
<b>BEIGE R11</b>	┌	147694	147702	147710	147718	147722	147726
	┐	147698	147706	147714			
<b>GRIS R11</b>	┌	147695	147703	147711	147719	147723	147727
	┐	147699	147707	147715			
<b>PORPHYRE R11</b>	┌	147696	147704	147712	147720	147724	147728
	┐	147700	147708	147716			
		1	1	1	1	1	1
		13,5	10,5	10,5	6	6	6
							

 Per maggiori informazioni sui SUPPORTI PER PAVIMENTAZIONI SOPRAELEVATE, potete consultare il nostro BOOK (anche da sito internet, nell'area "download").  
For more information on SUPPORTS FOR RAISED PAVING SYSTEM, please refer to our BOOK (also available for download on our website, in the "download" area).  
Pour plus d'informations sur les SUPPORTS POUR LES SYSTÈMES DE CARRELAGES SURÉLEVÉS, consultez notre BOOK (sur notre site, section « téléchargement »).  
Weitere Informationen zu STELZLAGERN FÜR DOPPELBODEN finden Sie in unserem BOOK (auch auf der Website, im Bereich „Download“).

\* A disposizione solo su richiesta. Tempi di consegna 30 gg.  
Available upon request only. Delivery terms: 30 days.  
Disponible seulement sur requête. Délais de livraison: 30 jours.  
Verfügbar auf Anfrage. Lieferzeit: 30 Tage.

□ Naturale e rettificato. Natural rectified. Naturel et rectifié. Natur Oberfläche und rektifiziert.

┌ Costa retta. Straight edge. Bord droit. Gerade Kante.

┐ Costa toro. Bullnose edge. Bord boudin. Abgerundete Kante.

# Suggerimenti per abbinare colori e stili Tagina

Tips for Matching Colours and Tagina Styles.

Conseils pour faire correspondre les couleurs et les styles Tagina.

Tipps für die Kombination von Tagina-Farben und -Stilen.



		BLANC	BEIGE	GRIS	PORPHYRE
CONCRETE & DESIGN	PIERRE D'AVIGNON <b>STEEL</b>	PLATINO	GRAFITE	IRIDIO	ARGENTO
	PIERRE D'AVIGNON <b>METAL</b>	CORTEN	PEARL	CORTEN	IRON
MARBLE & ONYX	PIERRE D'AVIGNON <b>LUCI D'ORO</b>	OSSIDIANA	DORATO	GHIACCIO	DORATO
	PIERRE D'AVIGNON <b>SEGESTA</b>	BLU	CAMEL	BLU	BLU
	PIERRE D'AVIGNON <b>CALACATTA GOLD</b>	CALACATTA GOLD	CALACATTA GOLD		CALACATTA GOLD
	PIERRE D'AVIGNON <b>STATUARIO</b>	STATUARIO	STATUARIO	STATUARIO	STATUARIO
	PIERRE D'AVIGNON <b>MARQUINA</b> *MARMI IMPERIALI **PATAGONIA	NERO	*ZENOBIA	NERO	**BIANCO
	Colore consigliato per la Fuga Recommended joint colour. Couleur d'échappement recommandée. Empfohlene Farbe für die Fuge.	RAL 9010 NCS 0502-Y07R	RAL 1015 NCS 1010-Y20R	RAL 7044 NCS 2005-G70Y	RAL 7013 NCS 7005-Y20R

## Pezzi speciali: massima cura in ogni dettaglio

Special pieces: the utmost care in every detail.

Pièces spéciales : le soin maximal dans le moindre détail.

Formteile: maximale Sorgfalt in jedem Detail.

### Il fascino tradizionale del gradino a "C"

**Tagina pone attenzione a tutte le componenti architettoniche degli spazi da abitare. Ai gradini sono dedicati pezzi speciali appositamente progettati per ottenere il massimo risultato estetico. La gamma comprende un elemento "gradino a C" al quale si possono affiancare gli elementi che completano gli angoli sinistro e destro.**

### The traditional appeal of the "C" step

Tagina takes great care over all the architectural elements of the living spaces. Special pieces are used for the stairs,

specially designed to obtain the maximum aesthetic result. The range includes a "C-step" element which can be combined with the elements that complete the left and right corners.

### Le charme traditionnel de l'étape « C »

Tagina prête attention à toutes les composantes architecturales des espaces de vie. Les étapes sont dédiées à des pièces spéciales spécialement conçues pour obtenir un résultat esthétique maximal. La gamme comprend un élément « marche en C » auquel vous pouvez assortir les autres éléments qui complètent les angles gauche et droit.

### Der traditionelle Charme der „C“-Stufe

Tagina achtet auf alle architektonischen Komponenten der Wohnräume. Den Stufen sind Spezialteile gewidmet, um ein optimales ästhetisches Ergebnis zu erzielen. Das Sortiment umfasst ein „C-Stufen-Element“, das durch Elemente zur Vervollständigung der linken und rechten Ecke ergänzt werden kann.

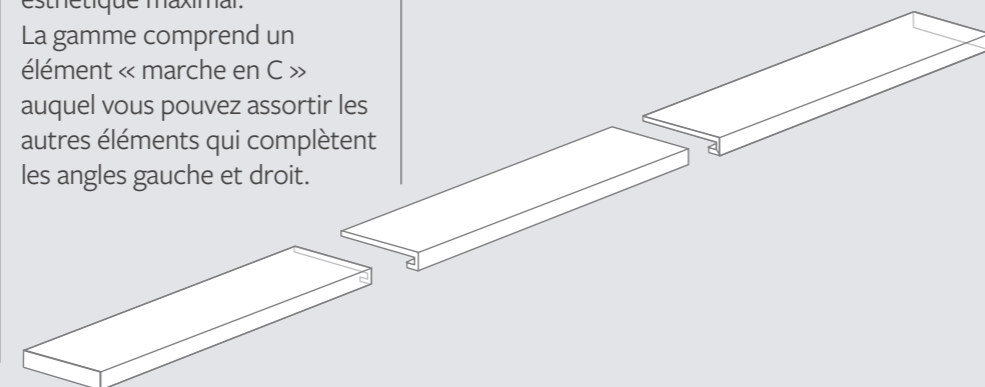

### Il "coprispigo triangolare"

**La gamma della collezione include l'elemento "Coprispigo triangolare" e "Angolo Coprispigo triangolare". Consentono di risolvere con eleganza e semplicità problematiche legate alla congiunzione delle lastre in presenza di spigoli e angoli. È possibile adottare questa soluzione sia a rivestimento che a pavimento ad esempio per realizzare gradini o per comporre volumi geometrici.**

### The "triangular edge cover"

The range of the collection includes the "Triangular edge cover and triangular corner edge cover" element. They allow problems encountered to be solved elegantly and simply when joining slabs where there are edges and corners. It is possible to adopt this solution both for cladding and flooring, e.g. to create steps or compose geometric volumes.

### Le « cache-arête triangulaire »

La gamme de la collection comprend l'élément « Cache-arête triangulaire et Angle Cache-arête Triangulaire ». Ils permettent de résoudre avec élégance et simplicité les problèmes liés à l'assemblage des dalles en présence de bords et de coins. Il est possible d'adopter cette solution aussi bien pour le revêtement que

pour le dallage, par exemple pour créer des marches ou composer des volumes géométriques.

### „Dreieckiger Kantenschutz“

Das Sortiment der Kollektion umfasst das Element „Dreieckiger Kantenschutz und Dreieckige Eckabdeckung“. Beide Elemente ermöglichen, mit Eleganz und Einfachheit alle Probleme zu lösen, die mit dem Zusammenfügen der Platten bei Vorhandensein von Kanten und Ecken zusammenhängen. Diese Lösung kann sowohl für Verkleidungen als auch für Böden verwendet werden, beispielsweise um Stufen oder geometrische Volumen zu schaffen.



















## CARATTERISTICHE TECNICHE

TECHNICAL FEATURES . CARACTERISTIQUES TECHNIQUES . TECHNISCHE EIGENSCHAFTEN

### GRES PORCELLANATO COLORATO IN MASSA

Full-body coloured porcelain stoneware / Grès cérame coloré dans la masse / In der Masse gefärbtes Feinsteinzeug.

CARATTERISTICA Specification Caractéristique Eigenschaft	NORMA Standards Norme Norm	RISULTATO PROVA Test results Résultats des essais Ergebnisse
 <b>Classificazione prodotto</b> Product classification Classification produit Produktklassifizierung	UNI EN 14411- Allegato G ISO 13006 UNI EN 14411- Appendix G ISO 13006 UNI EN 14411- Appendice G ISO 13006 UNI EN 14411- Anhang G ISO 13006	Gruppo B1a GL Group B1a GL Groupe B1a GL Gruppe B1a GL
 <b>Caratteristiche dimensionali e d'aspetto</b> Dimensional characteristics Caractéristiques dimensionnelles Abmessungen	UNI EN ISO 10545-2	Conforme alla norma. Complies with the standards. Conforme aux normes. Anforderungenerfüllt.
 <b>Assorbimento di acqua</b> Water absorption Absorption d'eau Wasseraufnahme	UNI EN ISO 10545-3	Conforme alla norma. Complies with the standards. Conforme aux normes. Anforderungenerfüllt.
 <b>Resistenza alla flessione</b> Breaking stress Résistance à la flexion Biegefestigkeit	UNI EN ISO 10545-4	Conforme alla norma. Complies with the standards. Conforme aux normes. Anforderungenerfüllt.
 <b>Sforzo di rottura</b> Breaking stress Effort de rupture Bruchkraft		Conforme alla norma. Complies with the standards. Conforme aux normes. Anforderungenerfüllt.
 <b>Resistenza all'abrasione delle piastrelle non smaltate</b> Deep abrasion resistance of unglazed tiles Résistance à l'abrasion profonde des carreaux non émaillés Beständig gegenüber Tiefenabrieb der unglasierten Fliesen	UNI EN ISO 10545-6	-
 <b>Resistenza all'abrasione delle piastrelle smaltate</b> Abrasion resistance of glazed tiles Résistance à l'abrasion des carreaux émaillés Abriebfestigkeit der glasierten Fliesen	UNI EN ISO 10545-7	Secondo quanto dichiarato. As stated by the Company. D'après déclaration de l'établissement. Entsprechend der Angaben des Unternehmens.
 <b>Dilatazione termica lineare</b> Linear thermal expansion Dilatation thermique linéaire Lineare Wärmedehnung	UNI EN ISO 10545-8	7x10 <sup>-6</sup> °C <sup>-1</sup>
 <b>Resistenza agli sbalzi termici</b> Thermal shock resistance Résistance aux écarts thermiques Beständigkeit gegenüber Temperaturschwankungen	UNI EN ISO 10545-9	Resistente. Resistant. Résiste. Erfüllt.
 <b>Resistenza al cavillo</b> Crazing resistance Résistance aux craquelures Beständigkeit gegenüber Glasurrissen	UNI EN ISO 10545-11	Resistente. Resistant. Résiste. Erfüllt.
 <b>Resistenza al gelo</b> Frost resistance Résistance au gel Frostbeständigkeit	UNI EN ISO 10545-12	Resistente. Resistant. Résiste. Erfüllt.
 <b>Resistenza ai prodotti chimici</b> Chemical resistance Résistance aux produits chimiques Beständig gegenüber Chemikalien	UNI EN ISO 10545-13	Resistente. Resistant. Résiste. Erfüllt.
 <b>Resistenza alle macchie</b> Stain resistance Résistance aux taches Beständigkeit gegenüber Flecken	UNI EN ISO 10545-14	Resistente. Resistant. Résiste. Erfüllt.
 <b>Stabilità dei colori alla luce</b> Colour stability upon exposure to light Stabilité des couleurs à la lumière Stabilität der Farben gegenüber dem Licht	DIN 51094	Conforme alla norma. Complies with the standards. Conforme aux normes. Anforderungenerfüllt.
 <b>Resistenza alla scivolosità</b> Friction coefficient (slip level) Coefficient de friction (glissance) Reibungskoeffizient (Glätte)	DIN 51130	A richiesta. / Available on request. / Sur demande. / Anforderungenerfüllt.
	DIN 51097	A richiesta. / Available on request. / Sur demande. / Anforderungenerfüllt.
	B.C.R.A.-D.M. 236/89	A richiesta. / Available on request. / Sur demande. / Anforderungenerfüllt.
	DCOF (BOOT 3000 -section 9.6 ANSI 137.2012)	A richiesta. / Available on request. / Sur demande. / Anforderungenerfüllt.
 <b>Resistenza al sale</b> Salt resistance Résistance au sel Beständigkeit gegenüber Salz	NaCl	Resistente. Resistant. Résiste. Erfüllt.
 <b>Resistenza al fuoco</b> Reaction to fire Réaction au feu Brandschutz kaasse	UNI EN 13501-1-2009	A richiesta. Available on request. Sur demande. Anforderungenerfüllt.

## CATALOGHISTICA TECNICA

TECHNICAL CATALOGUES . CATALOGUES TECHNIQUES . TECHNISCHE KATALOGE



### Inquadrare il qr code per scaricare i seguenti manuali tecnici

Scan the QR code to download the following technical manuals.

Scanner les code QR pour télécharger les manuels techniques suivants.

Scannen Sie die QR-Code, um die folgenden technischen Handbücher herunterzuladen.

### PULIZIA E MANUTENZIONE DEL PRODOTTO

Product cleaning and maintenance

Nettoyage et entretien du produit

Reinigung und Wartung des Produkts



### GRANDI FORMATI: GESTIONE ED OPERATIVITÀ

LARGE SIZES: management and operating

GRANDS FORMATS: gestion et fonctionnement

GROßFORMATE: Management und Betrieb



### PERSONALIZZARE LA SALA MOSTRA

Customising the showroom

Personnaliser la salle d'exposition

Den Ausstellungsraum individuell gestalten



### SCHEMI DI POSA

Laying patterns

Plans de pose

Verlegschema



### GUIDA AGLI ABBINAMENTI

Guide to pairings

Guide des combinaisons

Mögliche Farbkombinationen



### COLLECTIONS



## CERTIFICAZIONI

CERTIFICATIONS . CERTIFICATIONS . ZERTIFIZIERUNG



100% Made in Italy

Scopri la nuova App

# MY TAGINA

Uno strumento di lavoro innovativo,  
in esclusiva per i nostri clienti rivenditori

**Discover the new App MY TAGINA:**  
an innovative work tool,  
exclusively **for our reseller customers.**

A SET OF CLEAR,  
INTUITIVE, FAST AND  
EFFICIENT SERVICE,  
AVAILABLE 24 HOURS A  
DAY.

**Découvrez la nouvelle application MY TAGINA :**  
un outil de travail innovant,  
en exclusivité **pour nos clients revendeurs.**

UN ENSEMBLE DE  
SERVICES, CLAIR,  
INTUITIF, RAPIDE ET  
EFFICACE, DISPONIBLE  
24H/24.

**Entdecken Sie die neue App MY TAGINA:**  
ein innovatives Arbeitswerkzeug,  
exklusiv für **unsere Wiederverkäuferkunden.**

EINE REIHE VON  
DIENSTLEISTUNGEN, KLAR,  
INTUITIV, SCHNELL UND  
EFFIZIENT, 24 STUNDEN  
AM TAG VERFÜGBAR.

**UN INSIEME DI SERVIZI, CHIARO, INTUITIVO, RAPIDO ED EFFICIENTE, DISPONIBILE 24 ORE SU 24.**



**UN AMBIENTE DI LAVORO CON FUNZIONALITÀ AVANZATE PER LE ATTIVITÀ DI ACQUISTO, CONTROLLO E VENDITA, CONNESSO A TAGINA PER OTTENERE INFORMAZIONI IN TEMPO REALE.**

A work environment with advanced features for purchasing, control and sales activities, connected to Tagina to obtain information in real time.

Un environnement de travail avec des fonctionnalités avancées pour les activités d'achat, de contrôle et de vente, connecté à Tagina pour obtenir des informations en temps réel.

Eine Arbeitsumgebung mit erweiterten Funktionen für Einkaufs-, Kontroll- und Verkaufsaktivitäten, verbunden mit Tagina, um Informationen in Echtzeit zu erhalten.

**Scarica MyTagina e sperimenta un nuovo modo di interagire produttivamente e in tempo reale con l'azienda.**

Download My Tagina and experience a new way to interact productively and in real time with the company.

Téléchargez My Tagina et expérimentez une nouvelle façon d'interagir de manière productive et en temps réel avec l'entreprise.

Laden Sie My Tagina herunter und erleben Sie eine neue Art, produktiv und in Echtzeit mit dem Unternehmen zu interagieren.



**Tagina S.p.a. si riserva il diritto di apportare modifiche, in qualsiasi momento e senza preavviso, al packaging, alle grafiche, ai colori e ai decori dei prodotti raffigurati nelle immagini.**

Tagina S.p.a. reserves the right to make changes, at any time and without notice, to the packaging, graphics, colors, and decors of the products depicted in the images.

Tagina S.p.a. se réserve le droit d'apporter des modifications, à tout moment et sans préavis, à l'emballage, aux graphismes, aux couleurs et aux décors des produits représentés sur les images.

Tagina S.p.a. behält sich das Recht vor, jederzeit und ohne vorherige Ankündigung Änderungen an Verpackung, Grafiken, Farben und Dekoren der auf den Bildern abgebildeten Produkte vorzunehmen.

**Tutte le dimensioni degli articoli in gamma, riportate sul catalogo, si intendono nominali.**

All sizes of the items listed in the catalogue are nominal.

Toutes les dimensions des articles de la gamme, reportées sur le catalogue, s'entendent nominales.

Alle Größen der Produkte im Sortiment, die im Katalog angegeben sind, sind nominal.

Per le condizioni generali di vendita e le caratteristiche tecniche consultare [www.tagina.it](http://www.tagina.it)

General terms and Sales conditions and Technical features are available on our website [www.tagina.it](http://www.tagina.it)

Les Conditions général de vente et les Caractéristiques techniques sont disponibles sur le site web [www.tagina.it](http://www.tagina.it)

Allgemeine Verkaufsbedingungen und technische Eigenschaften sind auf unsere Website verfügbar: [www.tagina.it](http://www.tagina.it)

# Tagina

ITALY'S BEST SURFACES



**Tagina S.p.A.**  
Via Emilia Ponente, 925  
48014 Castel Bolognese (RA) - Italy  
Tel. +39 0545 197 7303 - tagina.it

Follow us

